

SAHIL ASHAR - CCS



DIGITAL MODELING & VISUALIZATION
PORTFOLIO



ABOUT ME

Hi, I'm Sahil, an Alias designer based in Detroit with a passion for digital modeling and vehicles. I thrive on transforming avant-garde ideas into 3D models while preserving the emotional essence of each form.

EDUCATION

College for Creative studies 2023-2026 (May)

BFA Transportation design

ArtCenter college of design 2021-2023

BSC Transportation design

EXPERIENCE

Force Motors Limited

R&D Body Design Trainee

Contributed conceptual interior proposals and 3D Data for an upcoming variant of the Urbania .Developed design proposals for the accessories of the Traveller.

CONTACT

Sashar@ccsdetroit.edu

+91 81979 17445

+1 626 567 9916

[LinkedIn](#)

sahilashar.myportfolio.com

SKILLS

Autodesk Alias NURBS & SUB D

Autodesk VRED

Unreal Engine 5

Blender

3D Printing and Rapid prototyping

Design Sketching & Photoshop

Design Thinking

CONTENTS

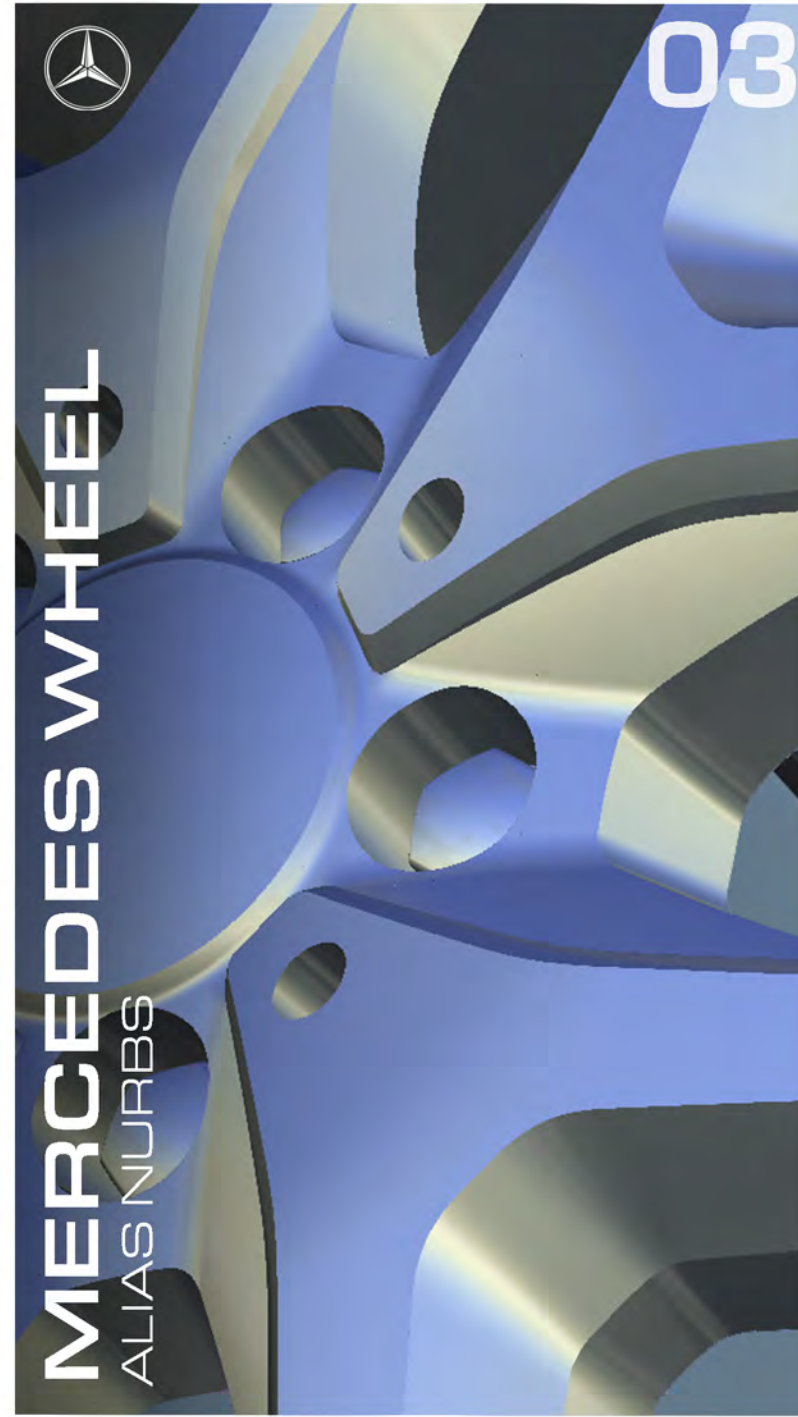



01

AUDI RSQ8

ALIAS SUB D & NURBS

Lorem ipsum dolor sit amet, consectetur adipiscing elit, sed do eiusmod tempor incididunt ut labore et dolore magna aliqua. Quis ipsum suspendisse ultrices gravida. Risus commodo viverra maecenas accumsan lacus

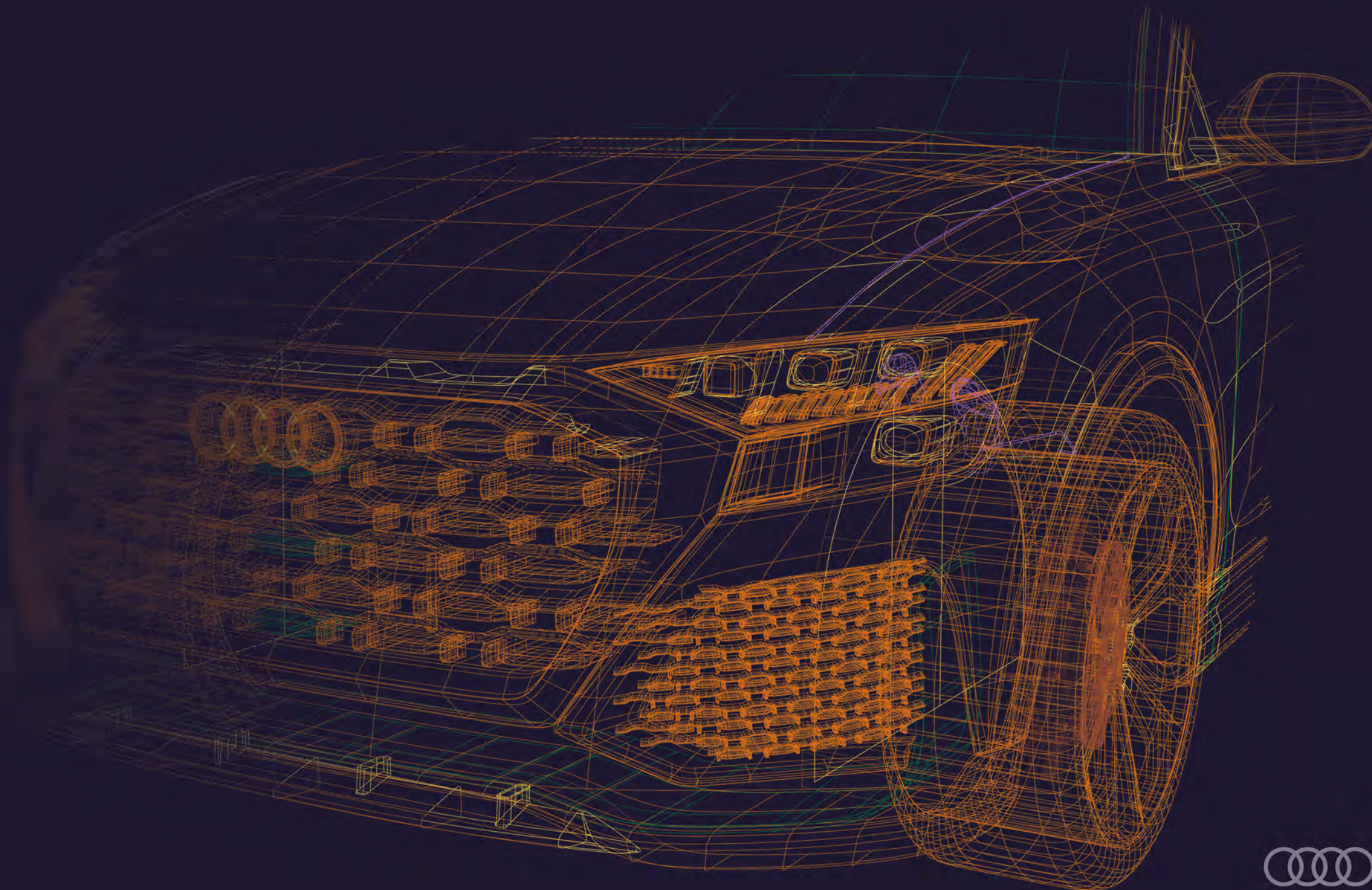

REFERENCE

01

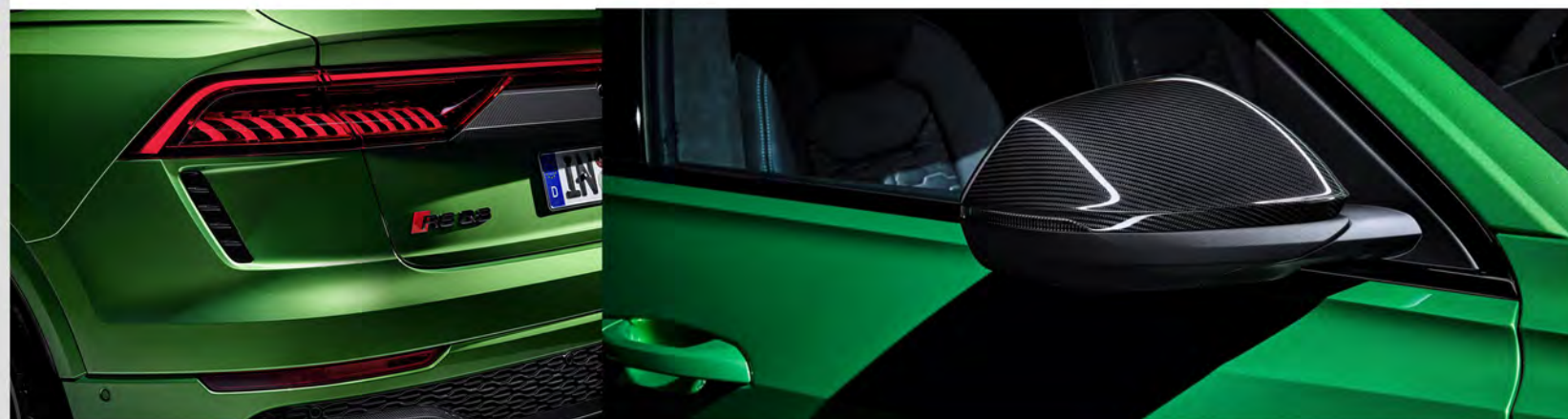

AUDI RSQ8



PROCESS



01

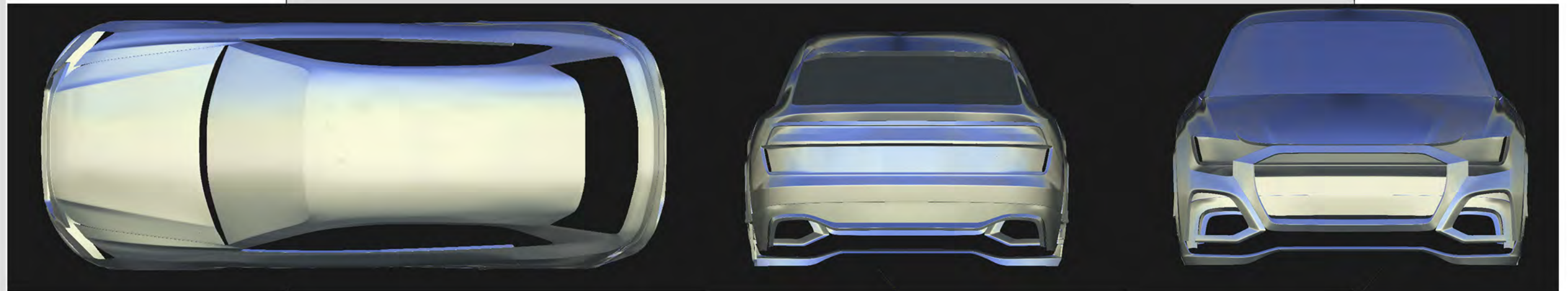

AUDI **RSQ8**



PATCH LAYOUT



01

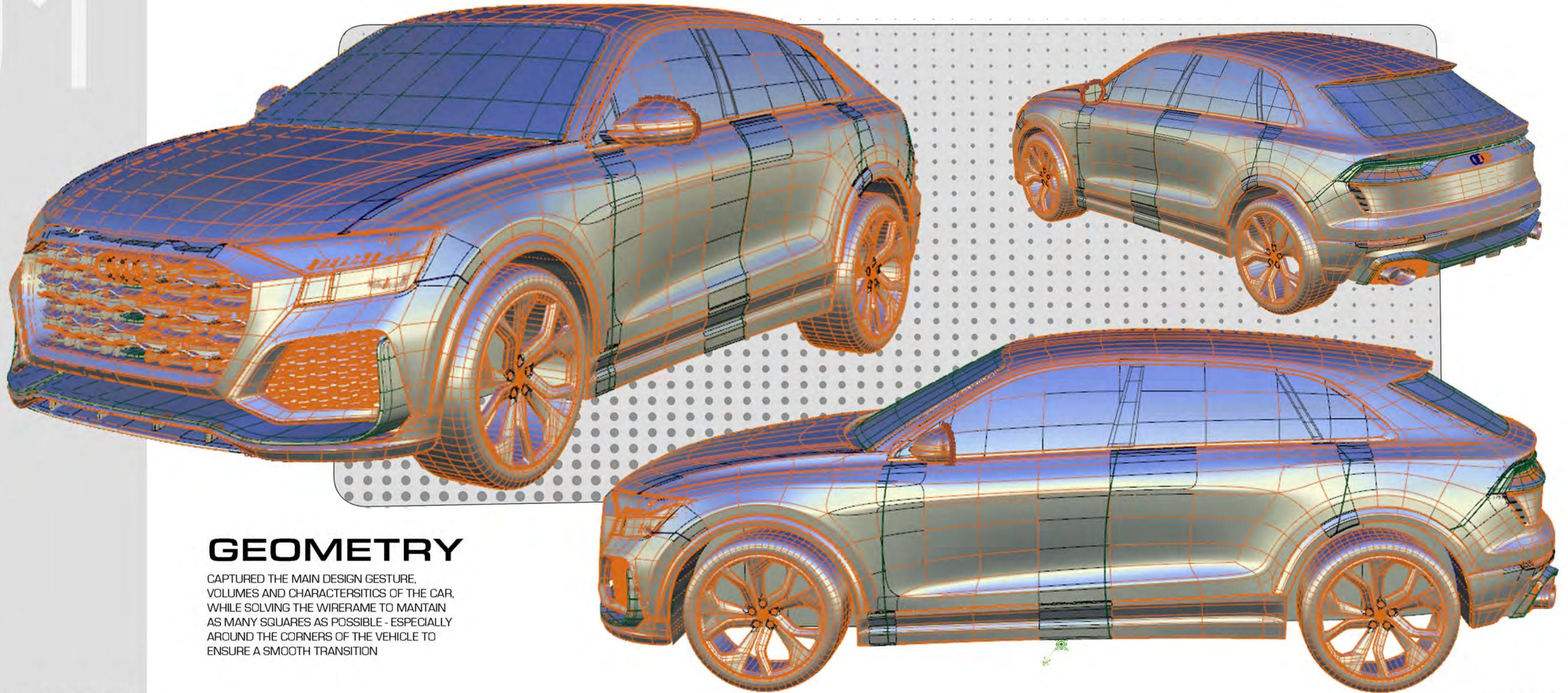

GEOMETRY

CAPTURED THE MAIN DESIGN GESTURE, VOLUMES AND CHARACTERISTICS OF THE CAR, WHILE SOLVING THE WIRERAME TO MAINTAIN AS MANY SQUARES AS POSSIBLE - ESPECIALLY AROUND THE CORNERS OF THE VEHICLE TO ENSURE A SMOOTH TRANSITION



ZEBRA - SHADER



01

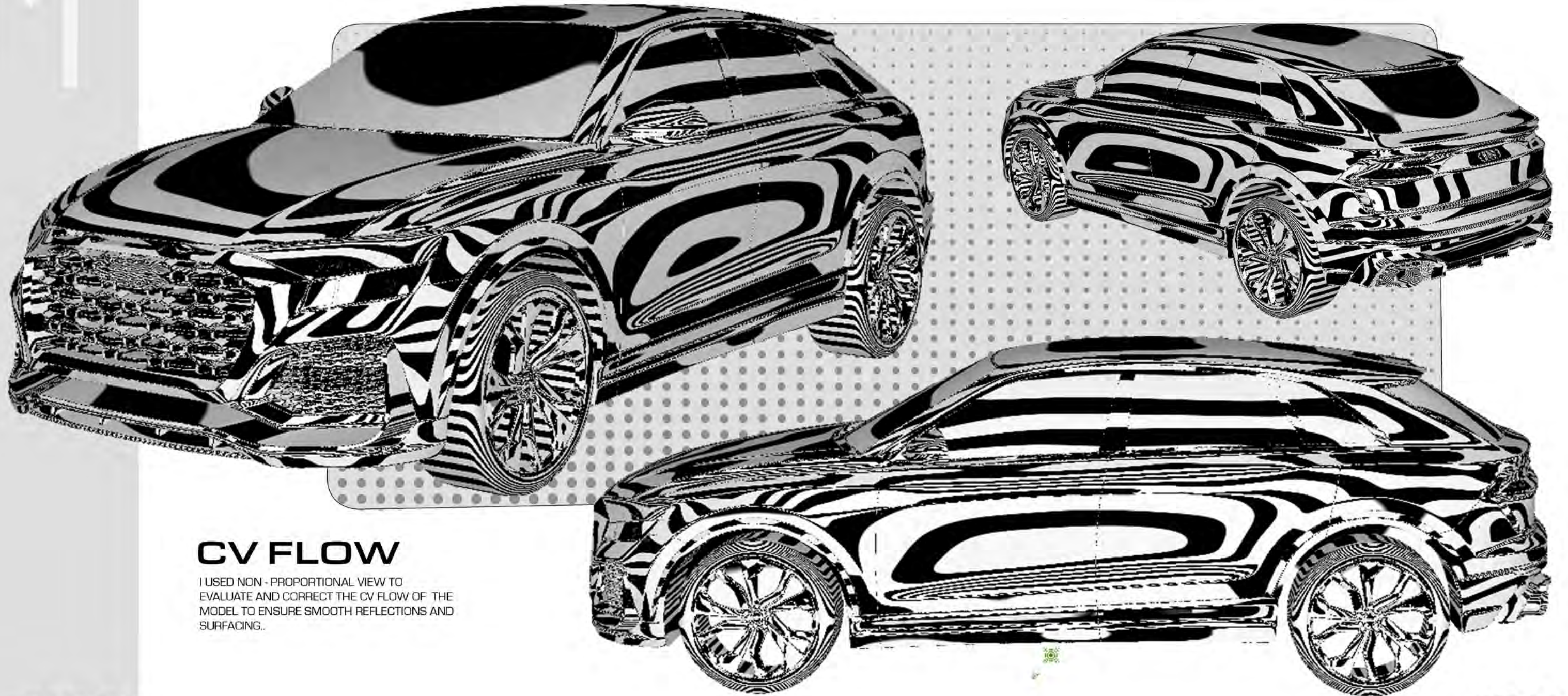

CV FLOW

I USED NON - PROPORTIONAL VIEW TO EVALUATE AND CORRECT THE CV FLOW OF THE MODEL TO ENSURE SMOOTH REFLECTIONS AND SURFACING.



VRED RENDERS



AUDI RSQ8



VRED RENDERS



AUDI RSQ8



VRED RENDERS



AUDI RSQ8





02

ASHAR - CRAFT 37

ALIAS SUB D & NURBS

Lorem ipsum dolor sit amet, consectetur adipiscing elit, sed do eiusmod tempor incididunt ut labore et dolore magna aliqua. Quis ipsum suspendisse ultrices gravida. Risus commodo viverra maecenas accumsan lacus

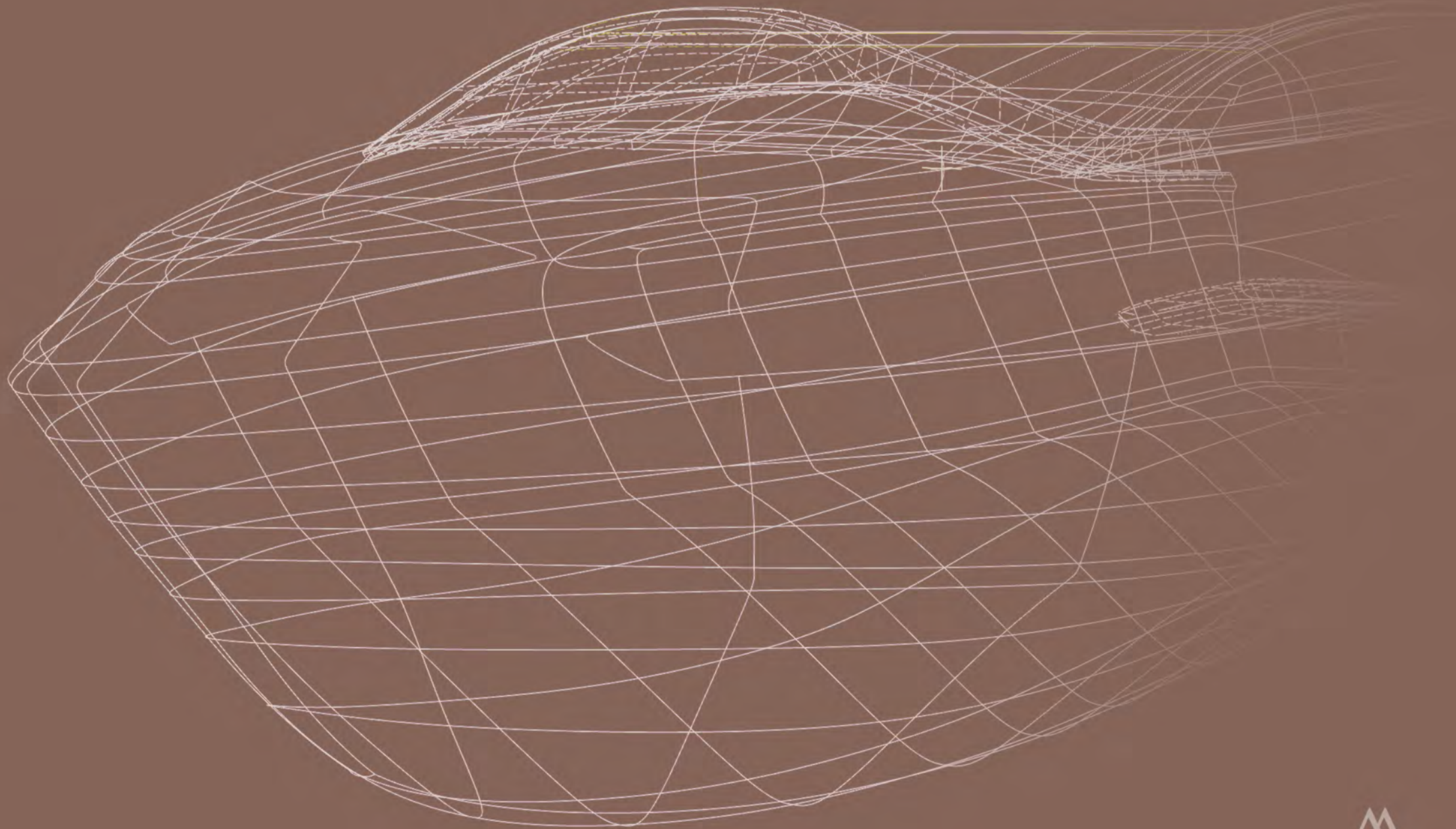

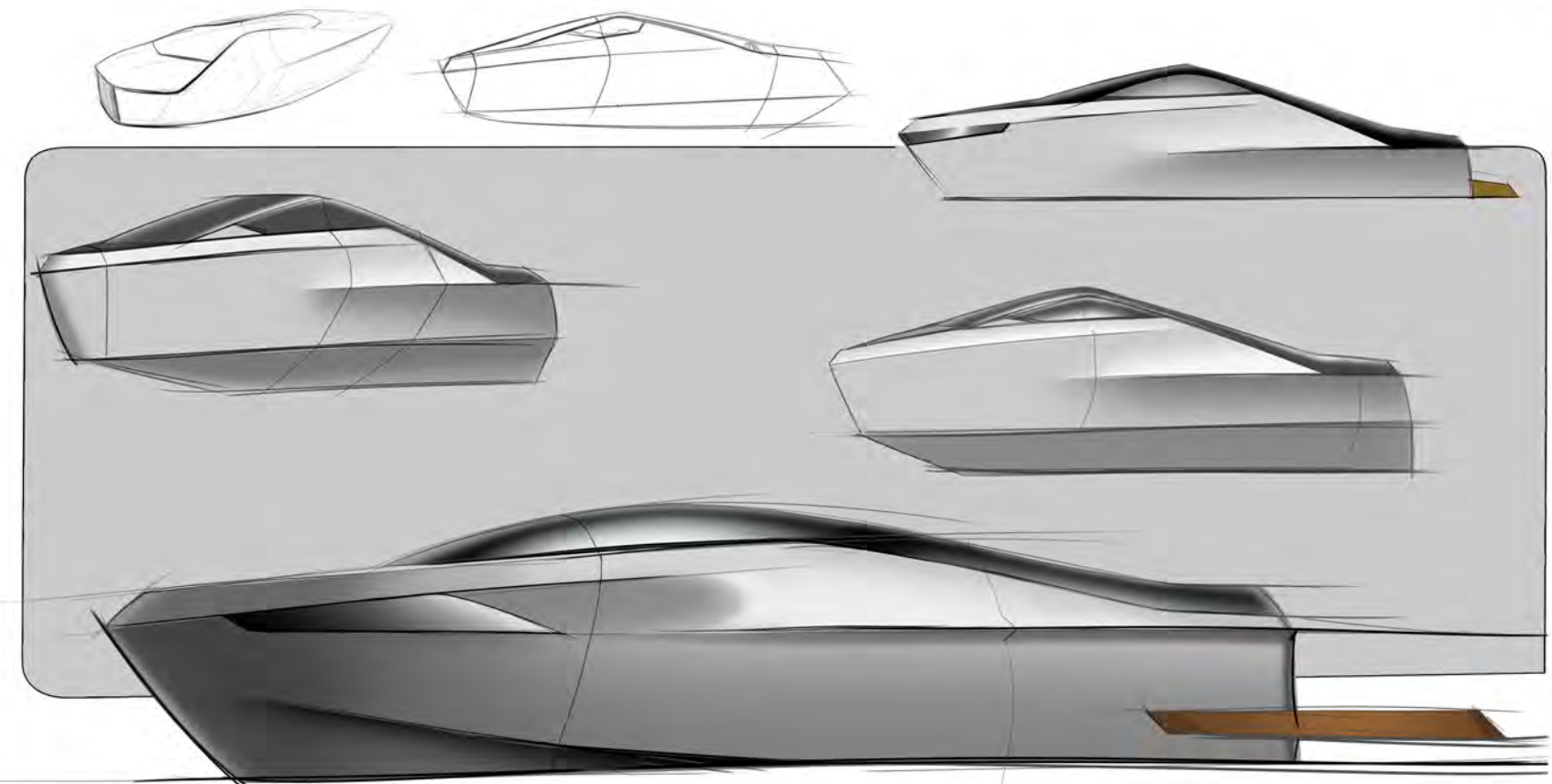
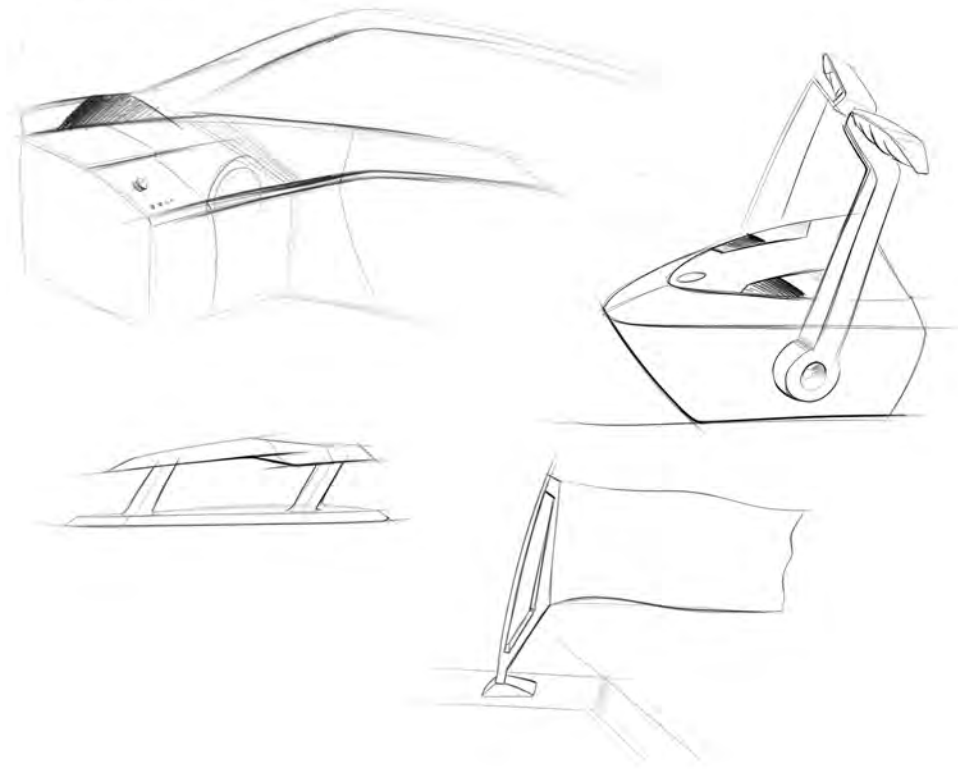

Ideation

I took inspiration from the architecture and nightlife of Miami. I used the main design gesture and design elements to create the details of the boat.

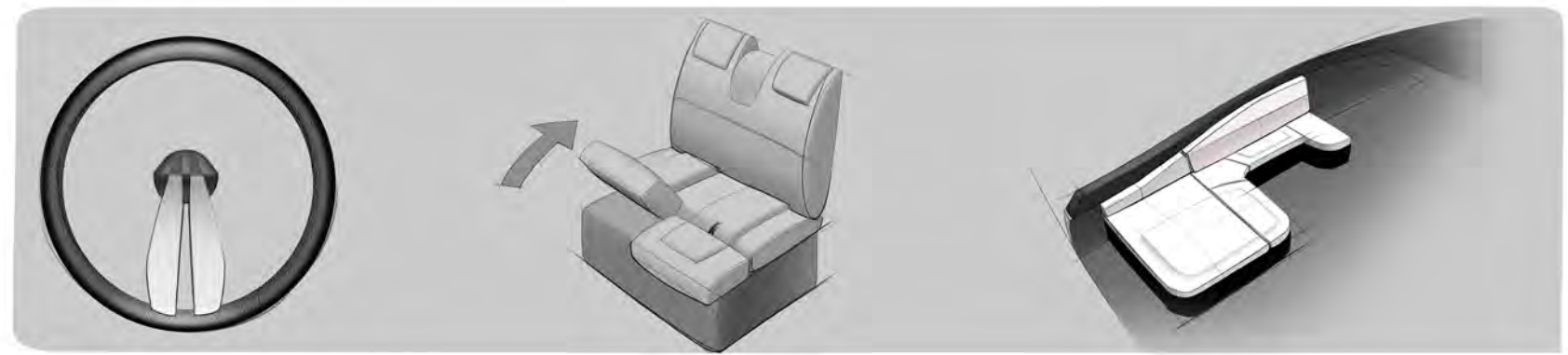

SKETCHES

02

PACKAGE DRAWING 2027 ASHAR - CRAFT 37

LOA - 36' 10" FT
BEAM - 11' 9" FT
DRAFT - 2' 9" FT
CABIN HEIGHT - 5' 2" FT
FREE BOARD - 3' 3" FT
BRIDGE CLEARANCE - 6" FT

COCKPIT SOLE - 45 Inches
COCKPIT SOLE - WATERLINE - 9 Inches
COCKPIT SOLO BEAM - 9' 5" Ft
MERCURY VERADO 350 HP X2
SCALE 1:12 1 SQ = 1FT

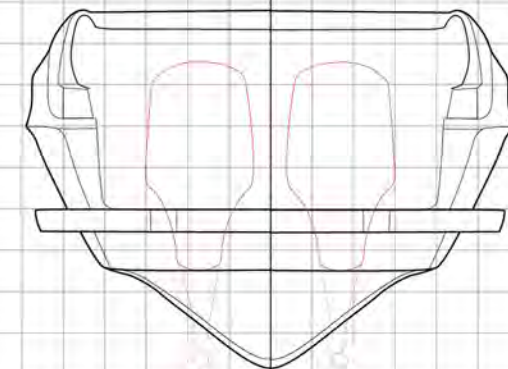
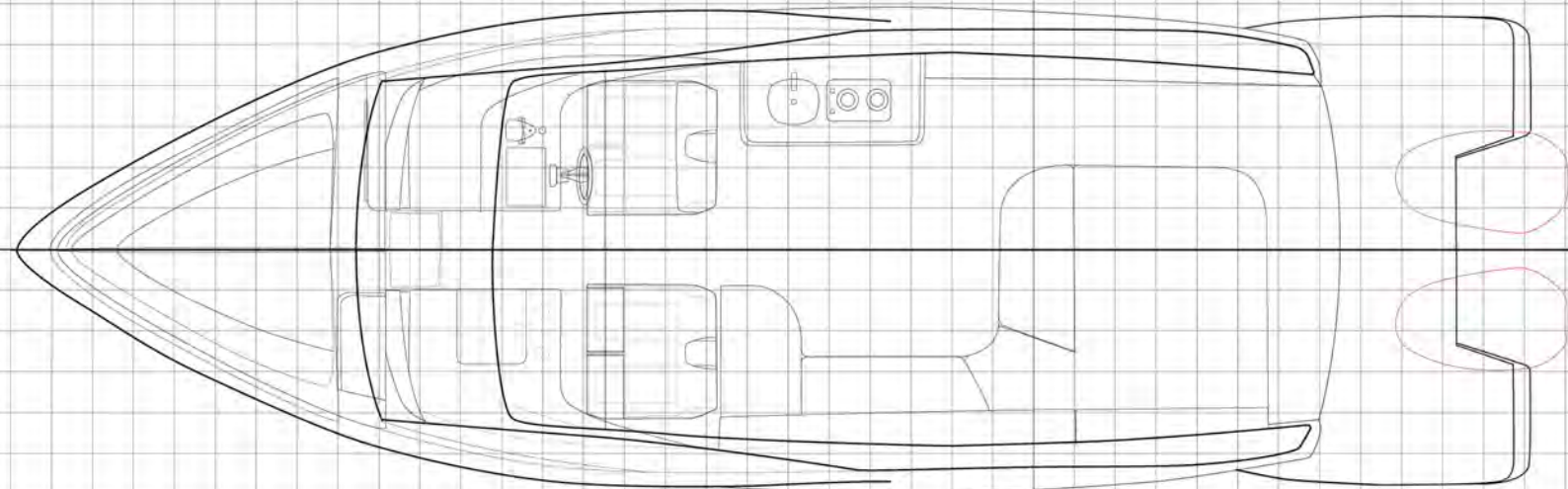
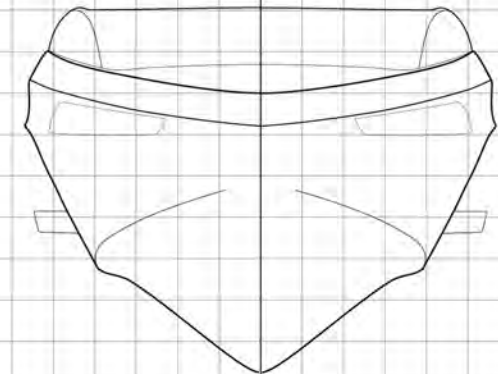
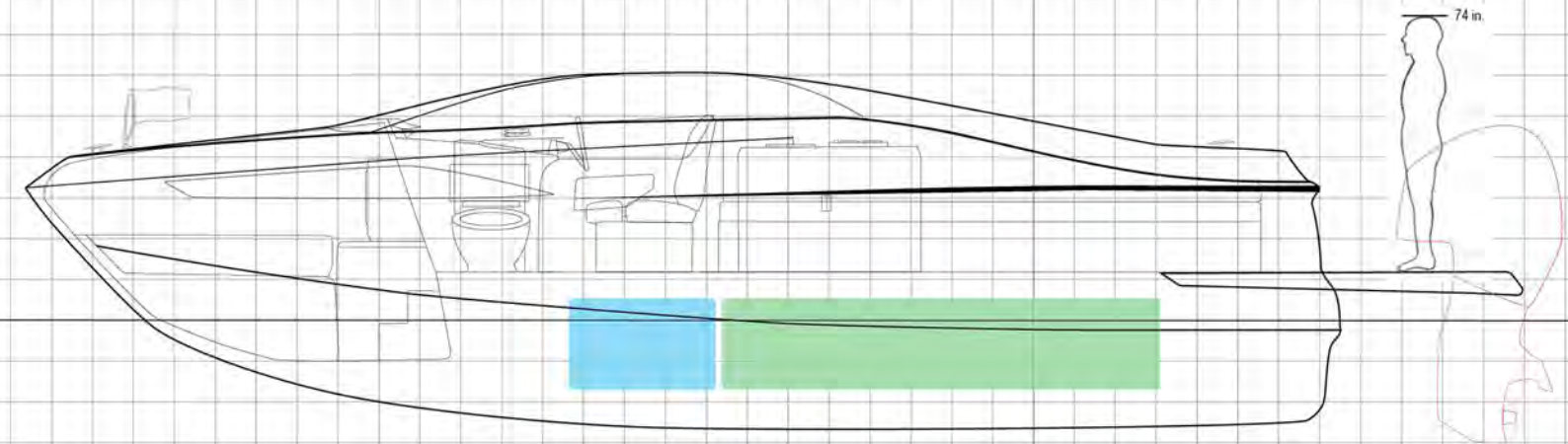

PROCESS



02

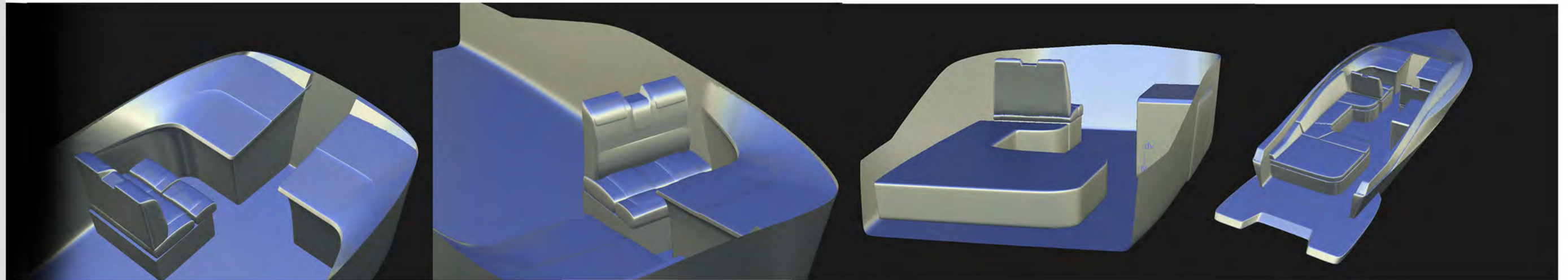
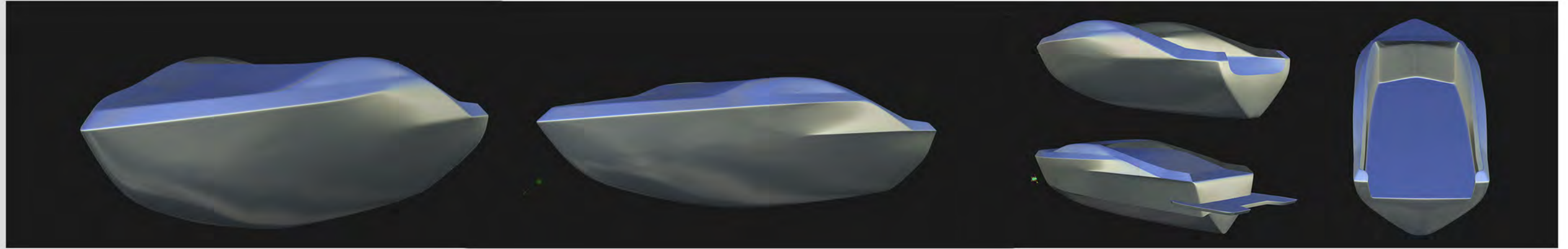

SKY-SHADER

02

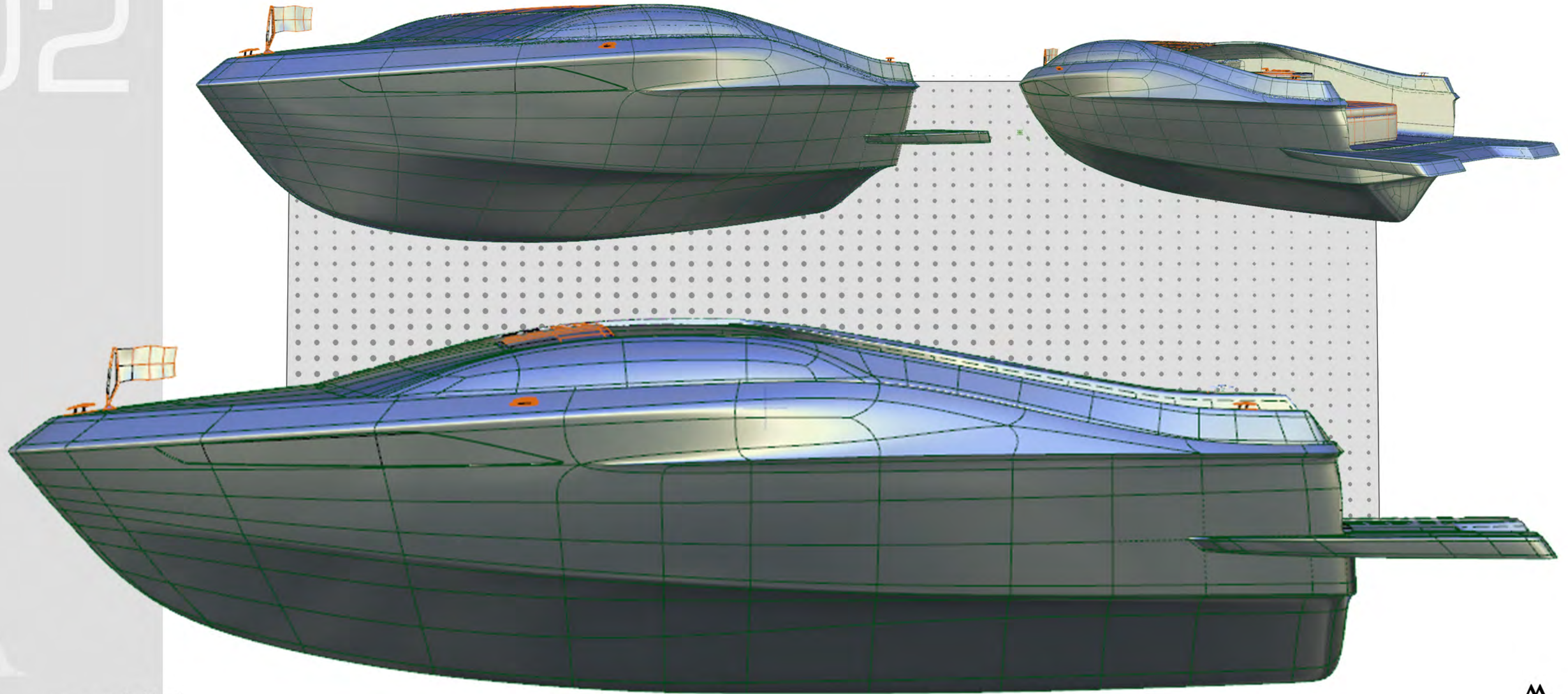

SKY-SHADER

02

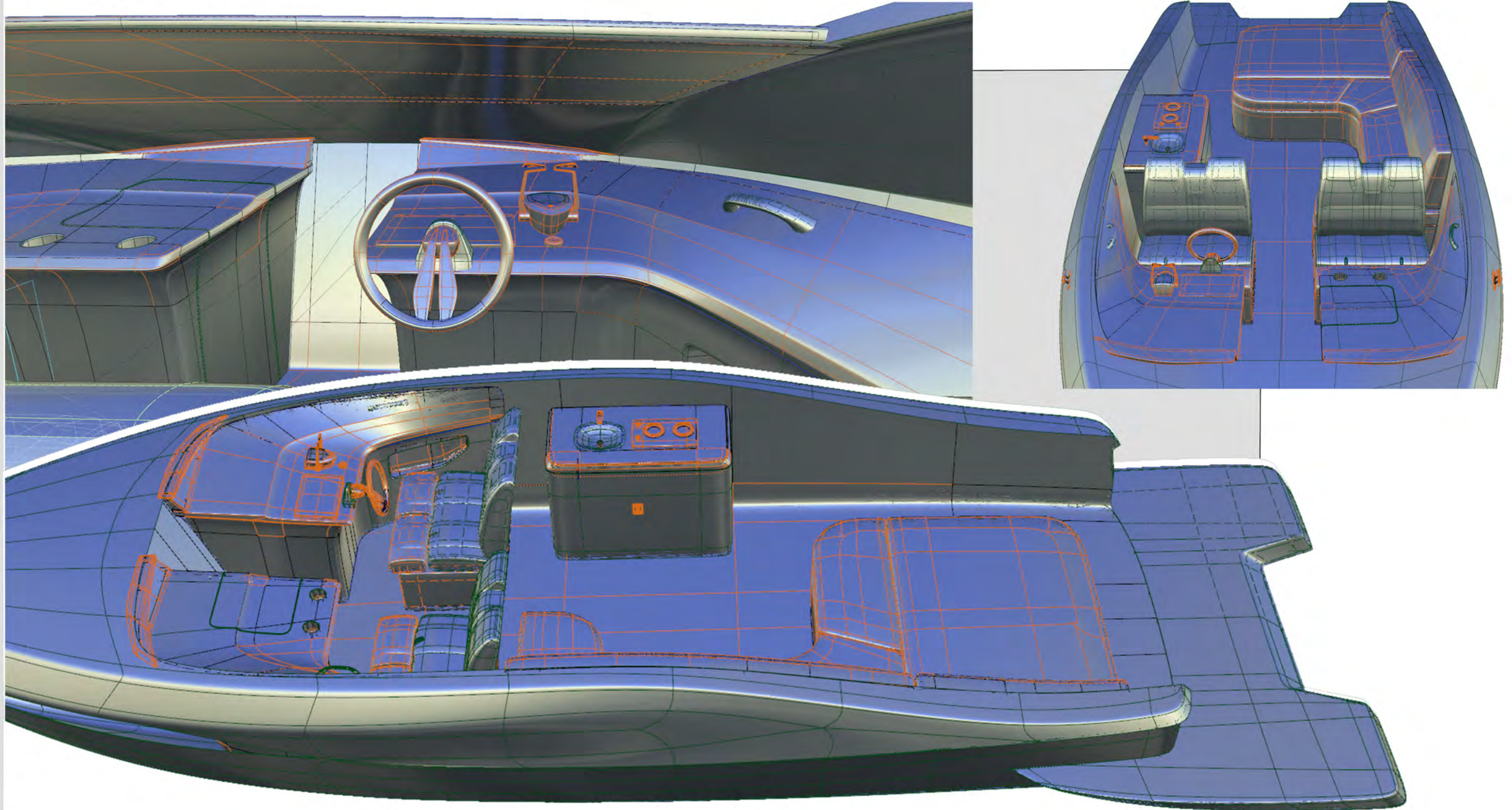

SKY-SHADER

02

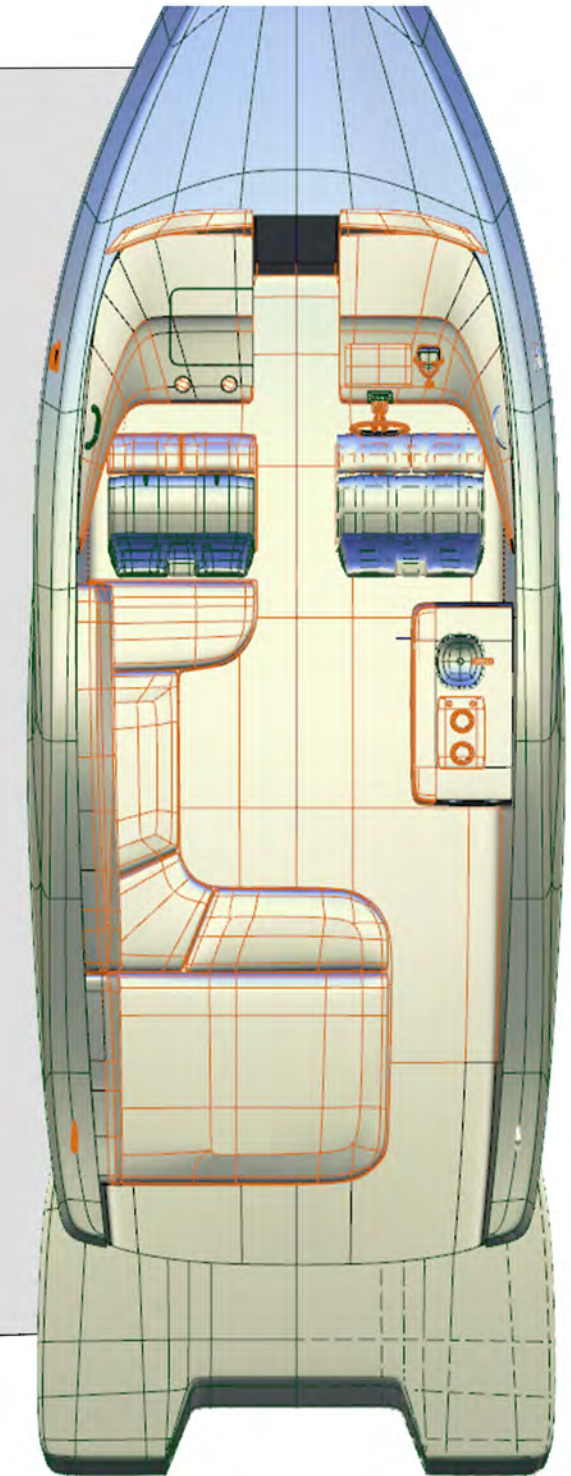
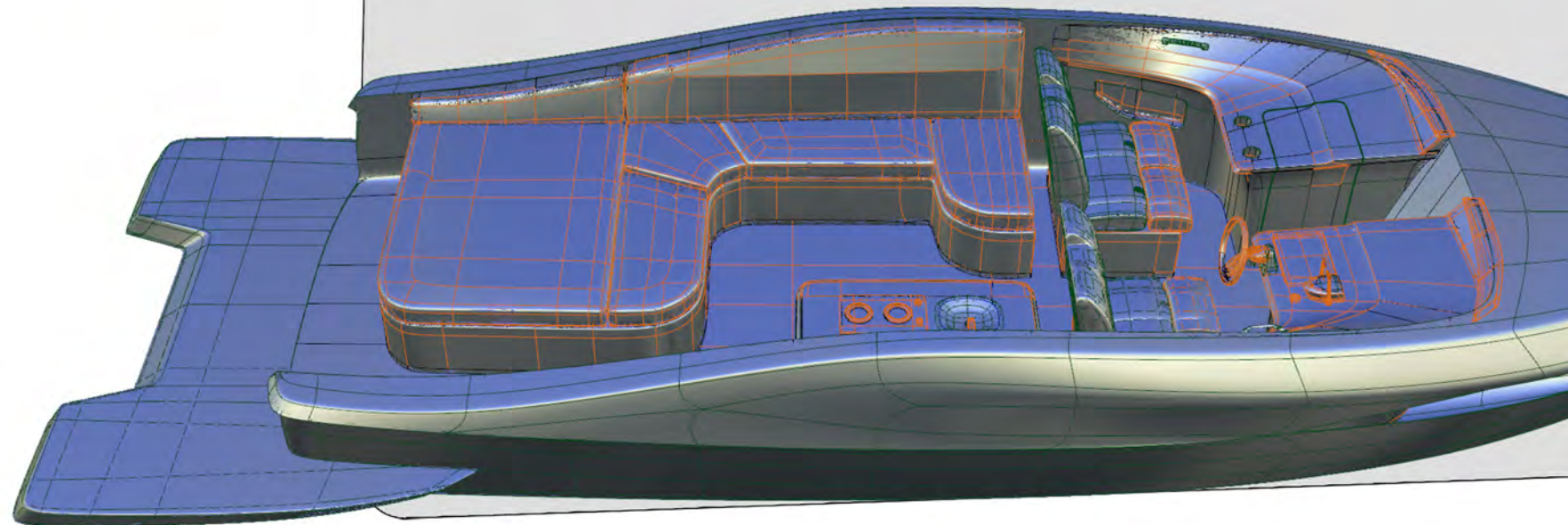
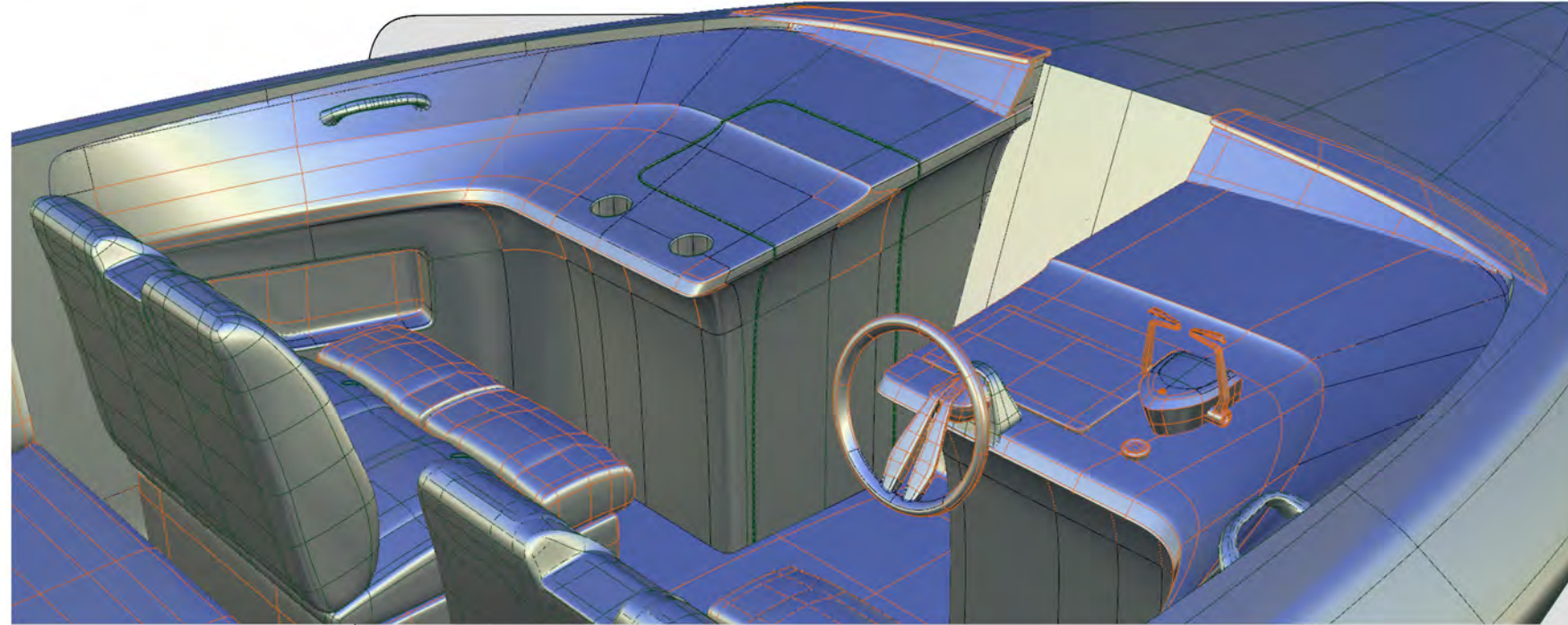

VRED RENDERS



ASHAR 37



VRED RENDERS



VRED RENDERS

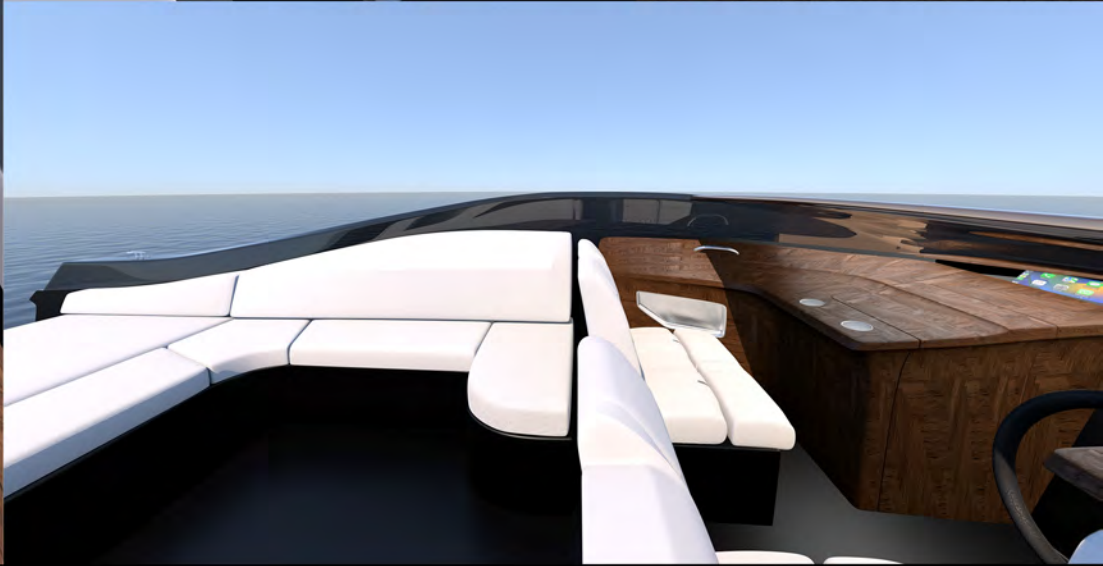
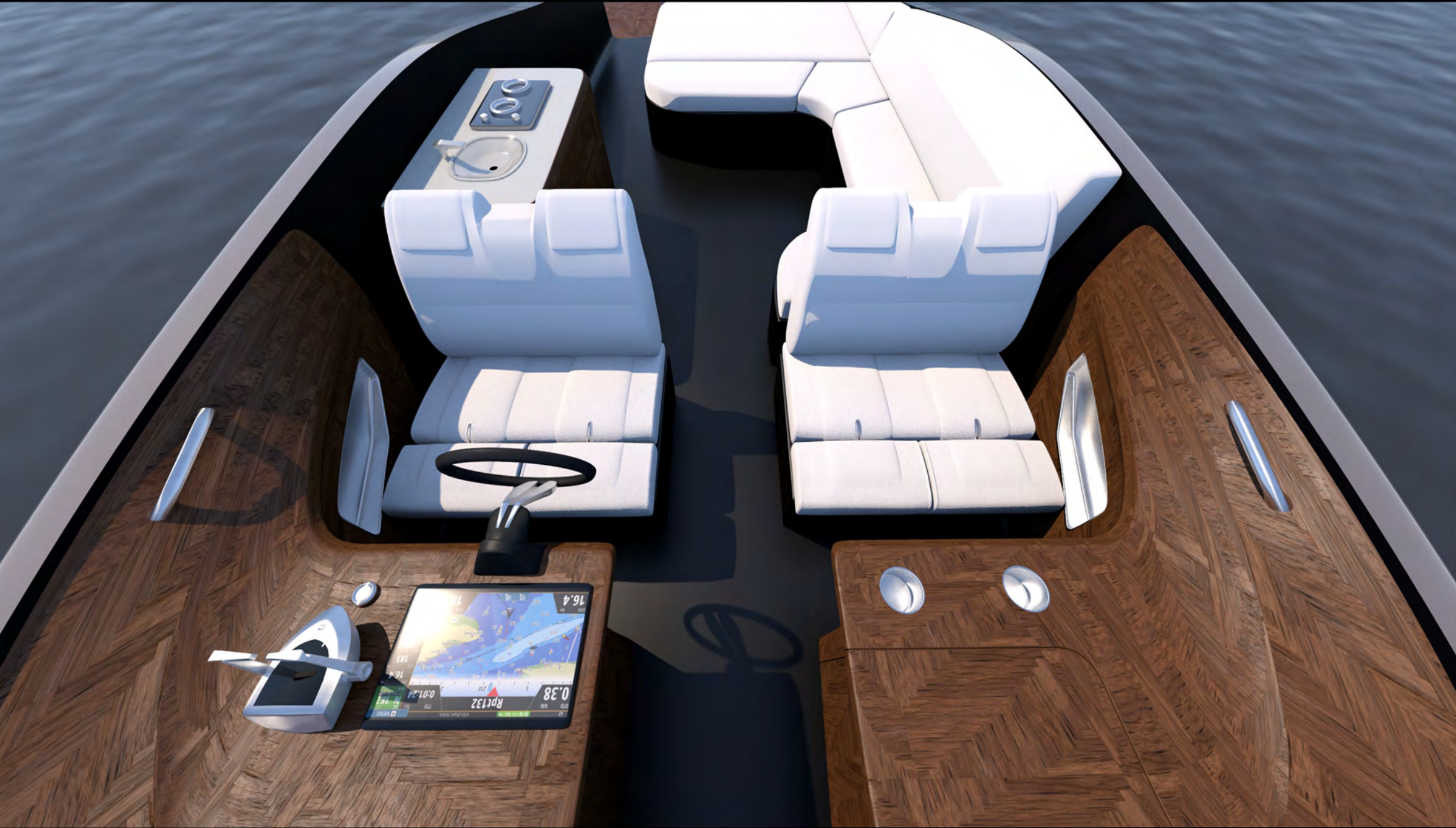



03

Mercedes AMG WHEEL

ALIAS NURBS

Lorem ipsum dolor sit amet, consectetur
adipiscing elit, sed do eiusmod tempor
incididunt ut labore et dolore magna aliqua. Quis
ipsum suspendisse ultrices gravida. Risus
commodo viverra maecenas accumsan lacus

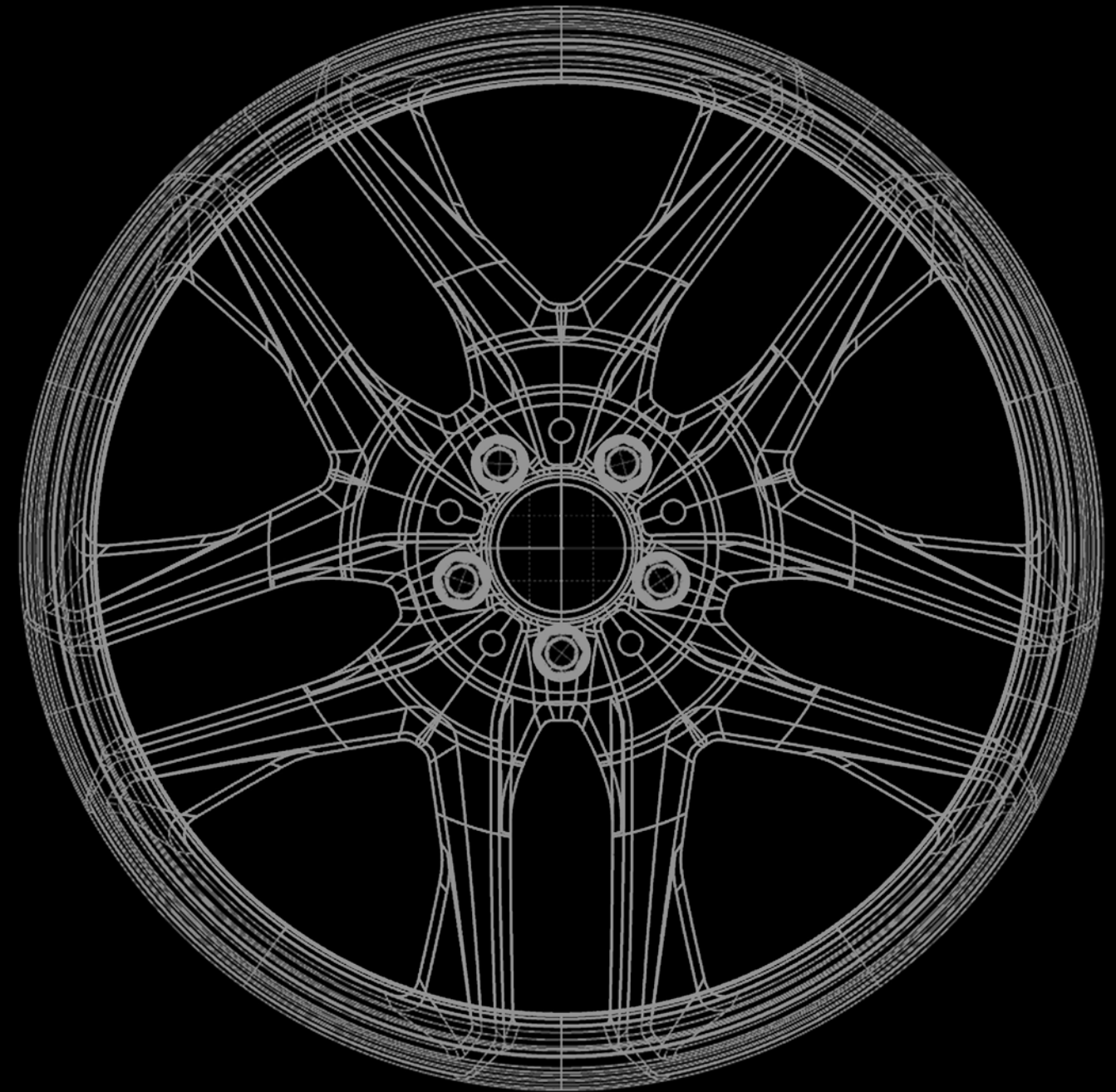

REFERENCE

03



MERCEDES **AMG**



PROCESS

03



1. Primary Surfaces



2. Fillets

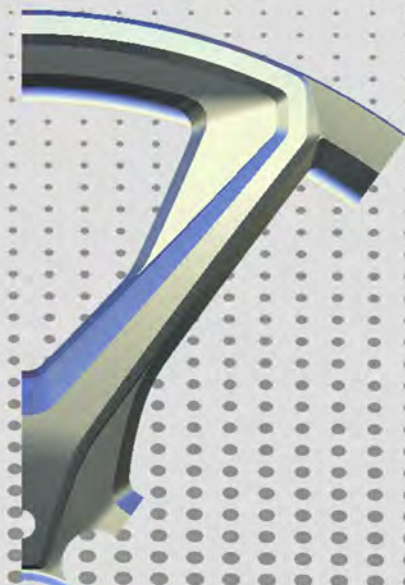

3. Mirror

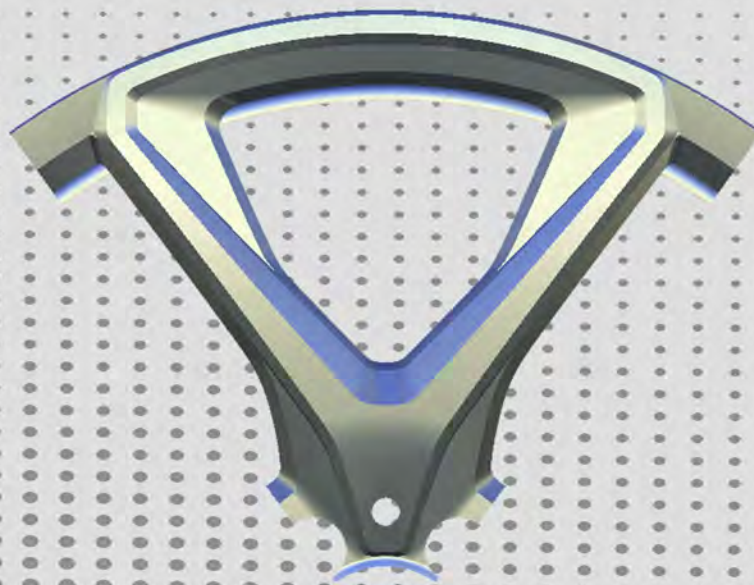

4. Duplicate

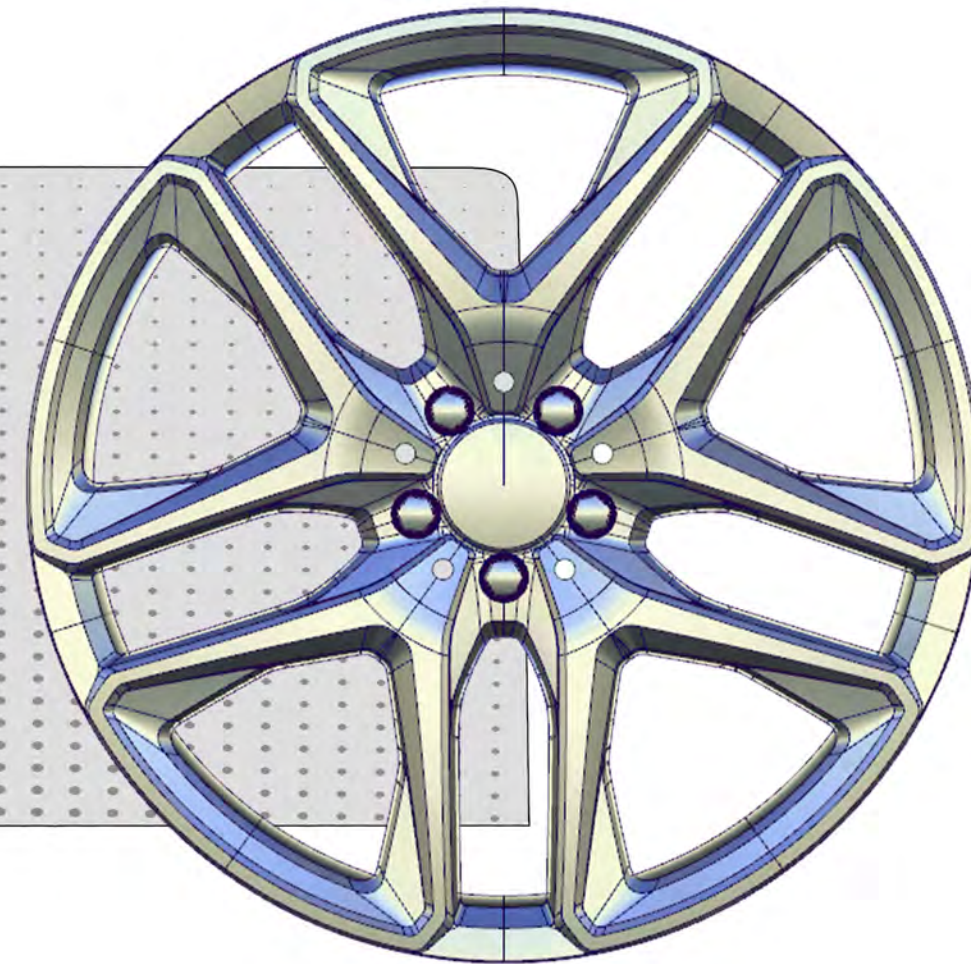

SKY SHADER

03

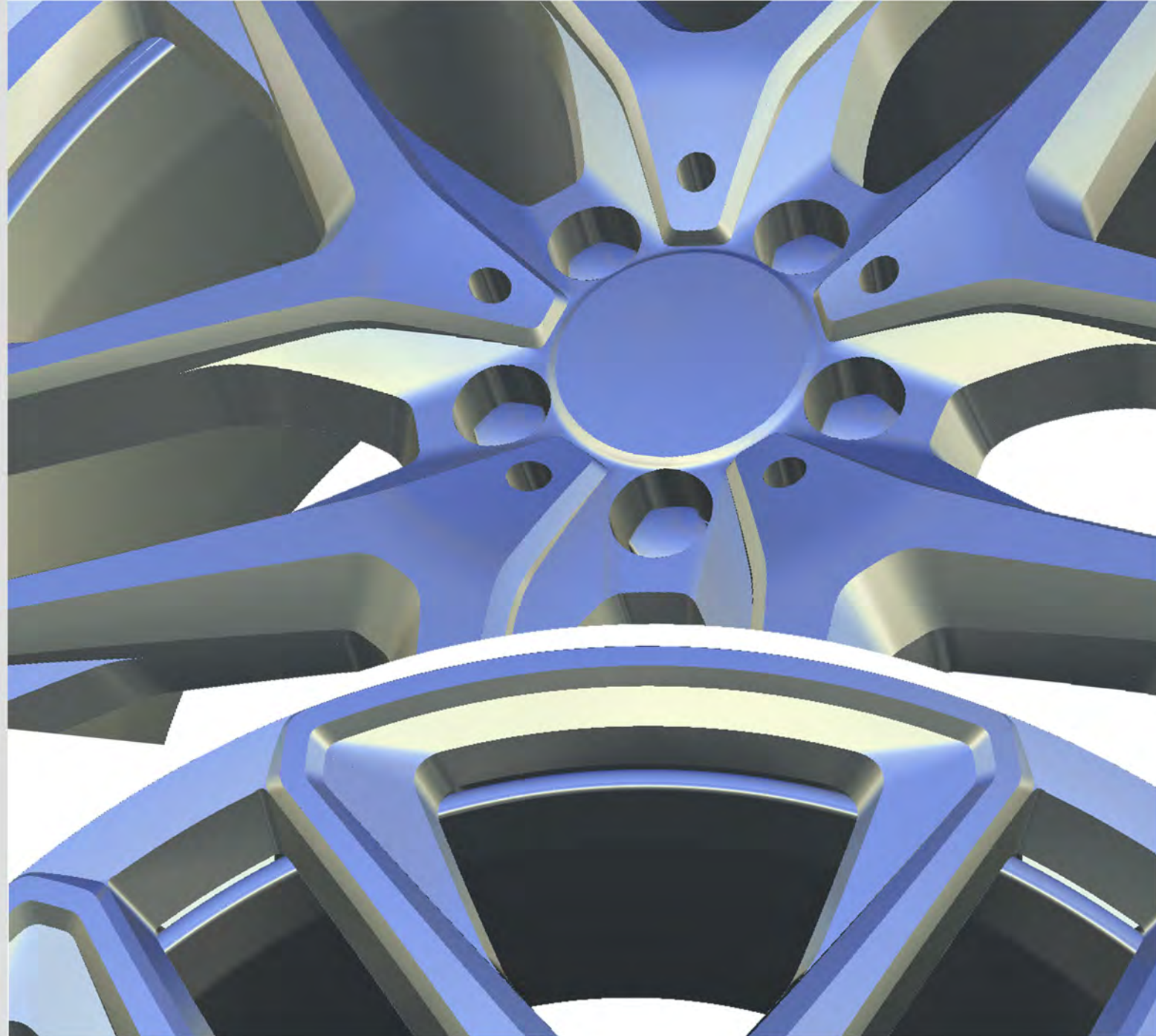

MERCEDES **AMG**



WIREFRAME

03

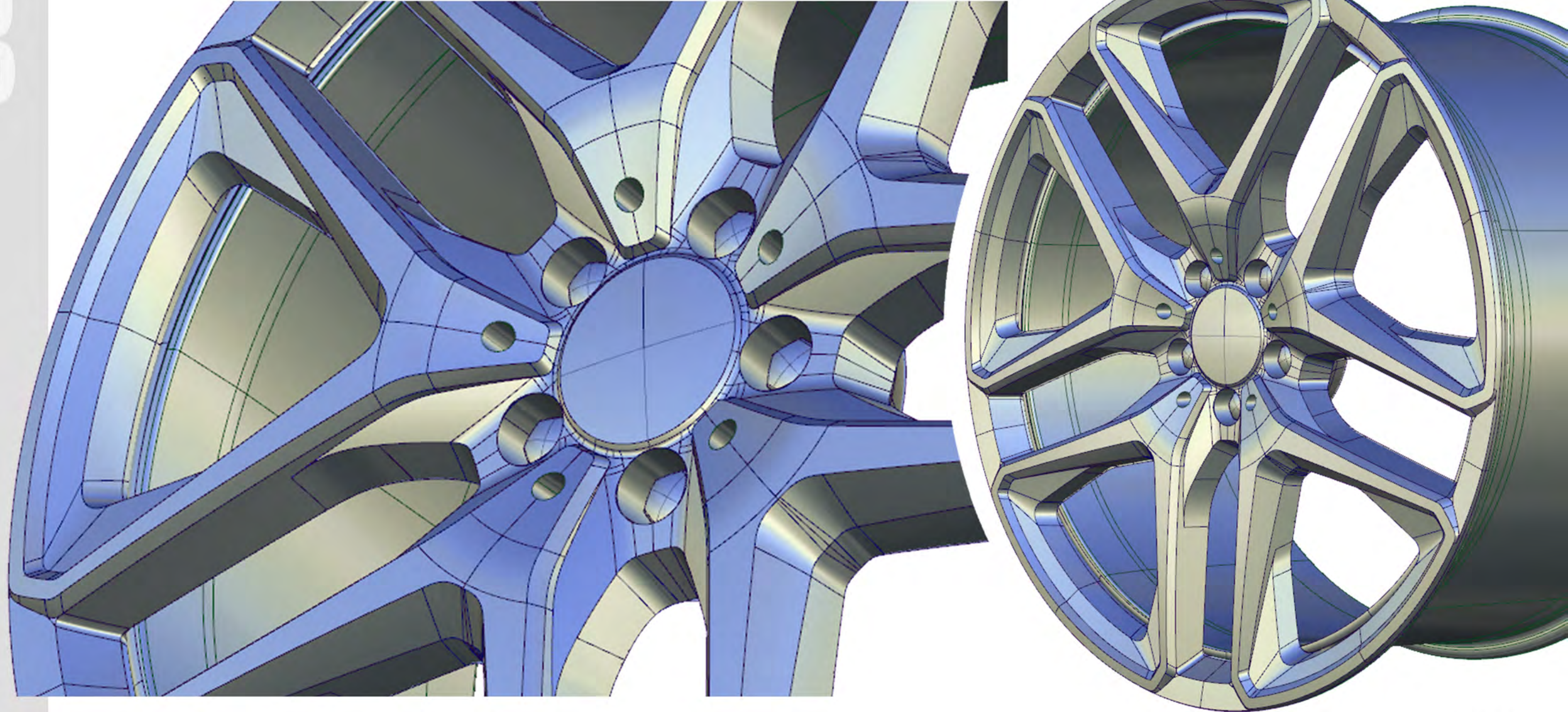

MERCEDES **AMG**



ZEBRA SHADER



03

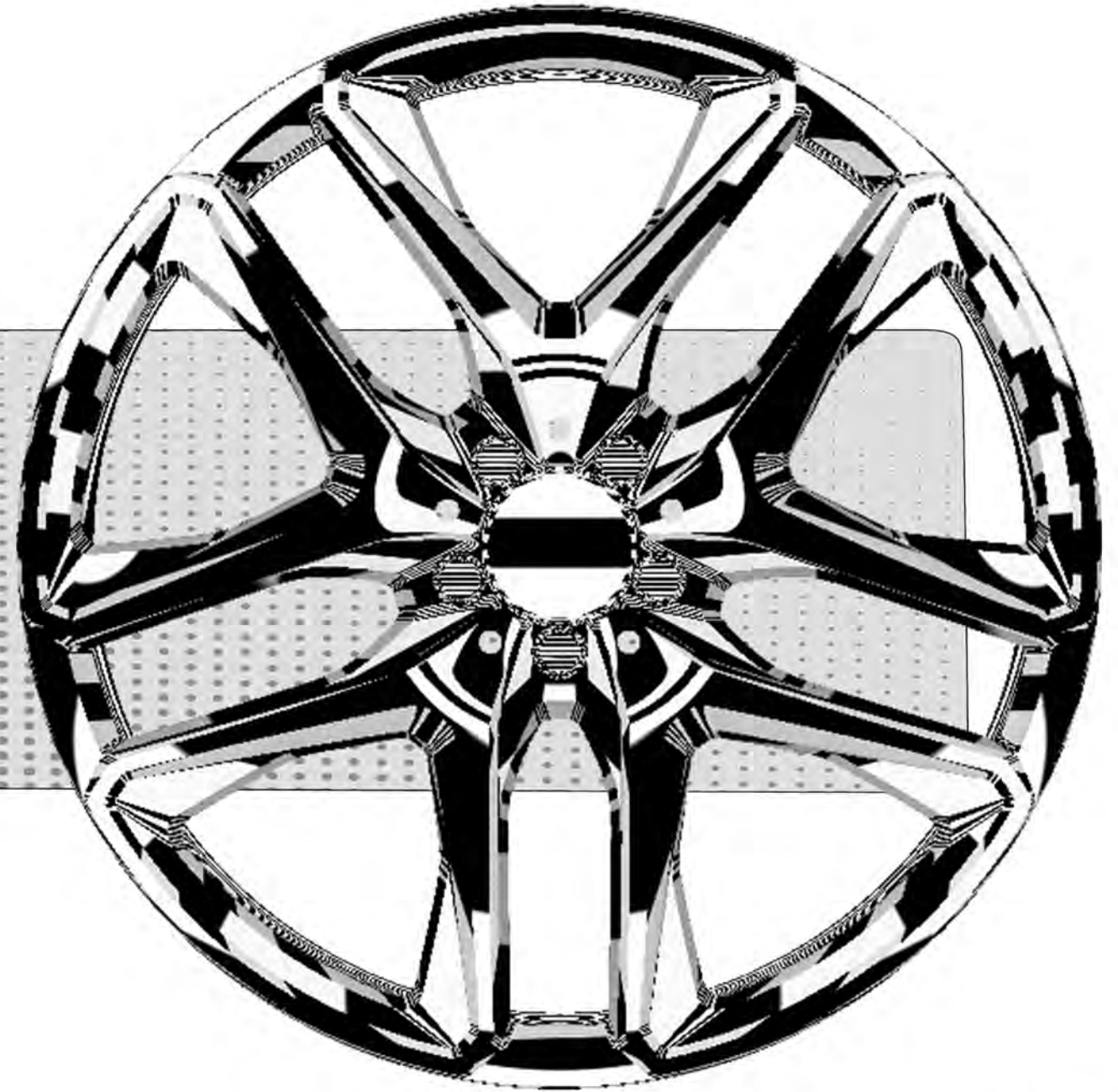

MERCEDES **AMG**



VRED RENDERS





VISCOM + DESIGN

ANALOG + DIGITAL - 2021-2025

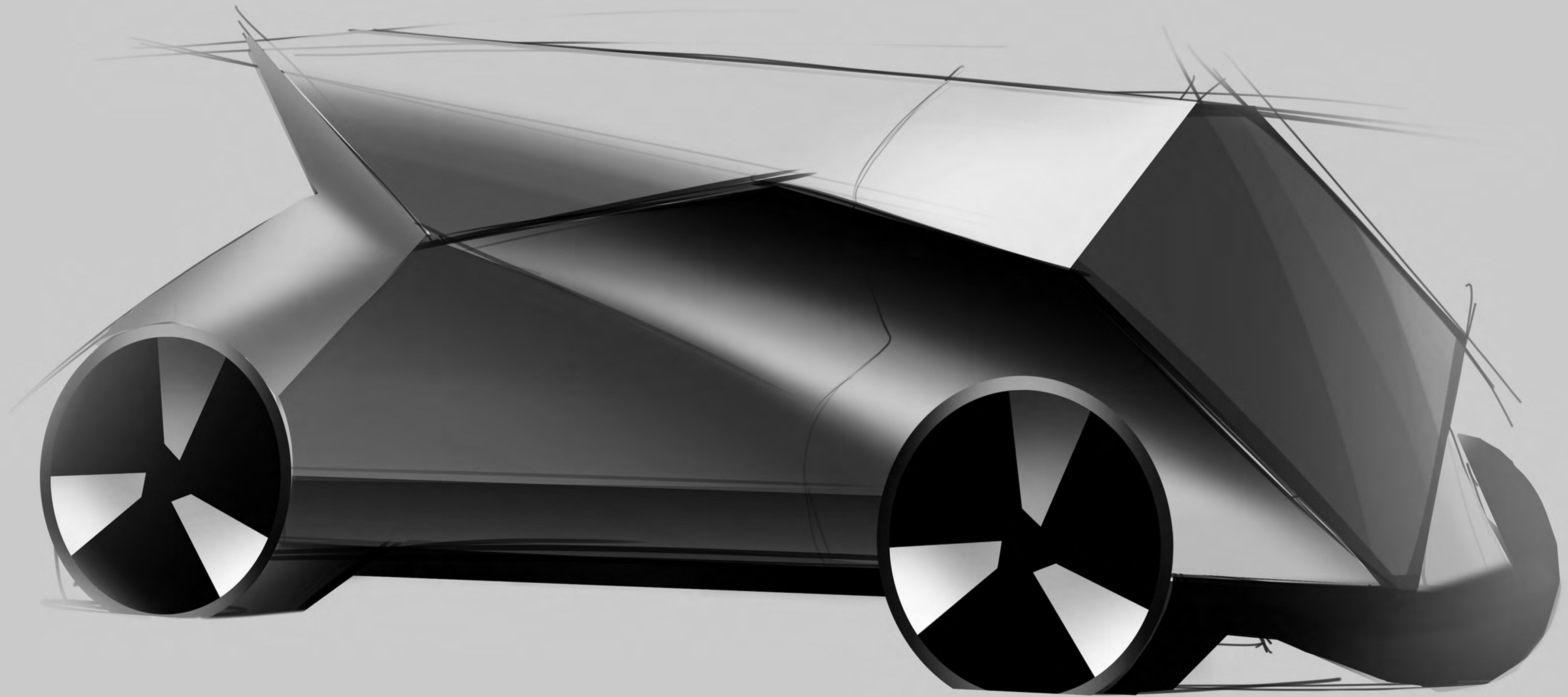



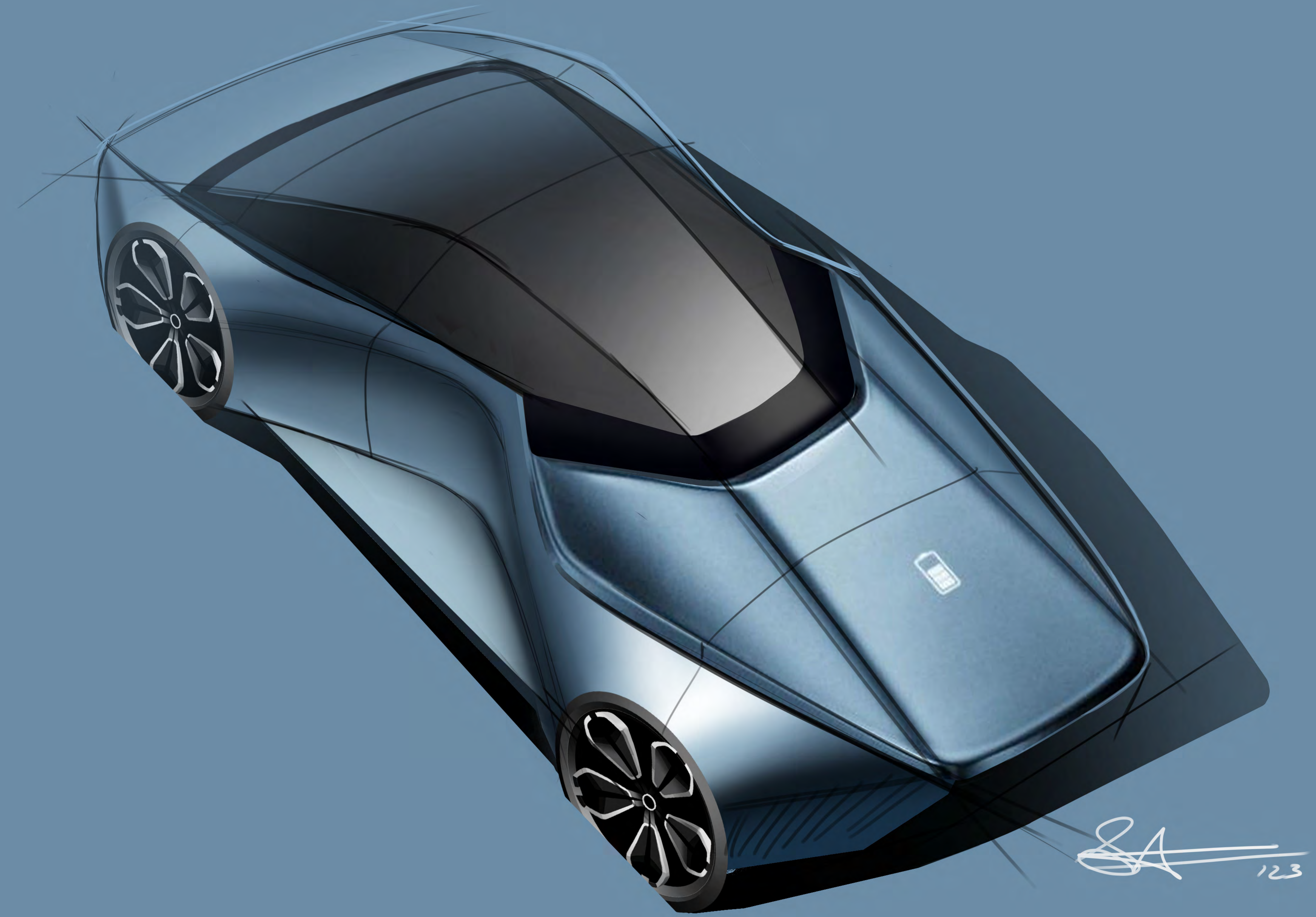

SKETCH TO MODEL PROCESS



04

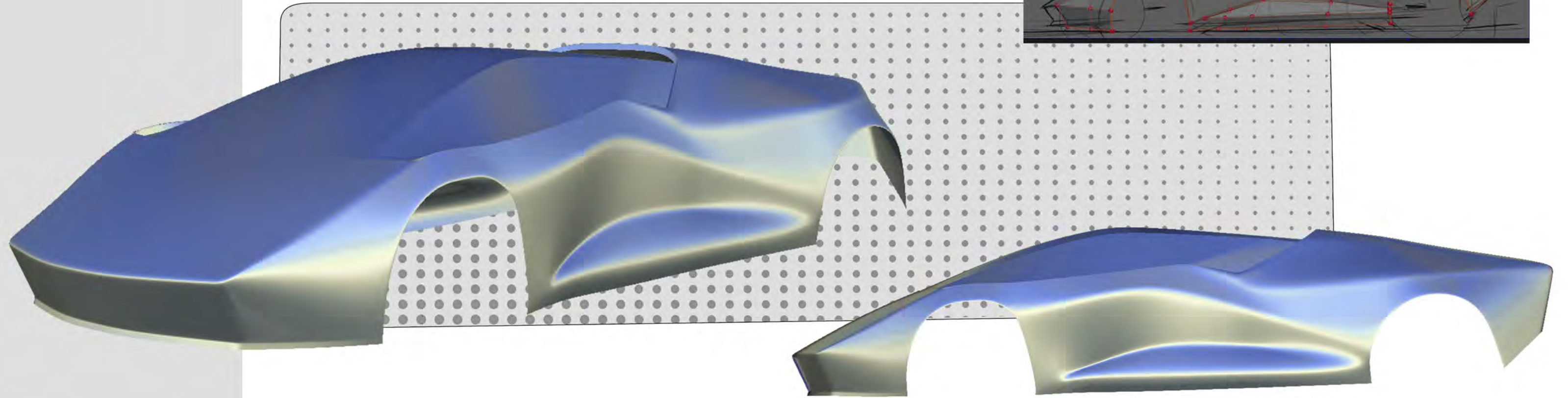
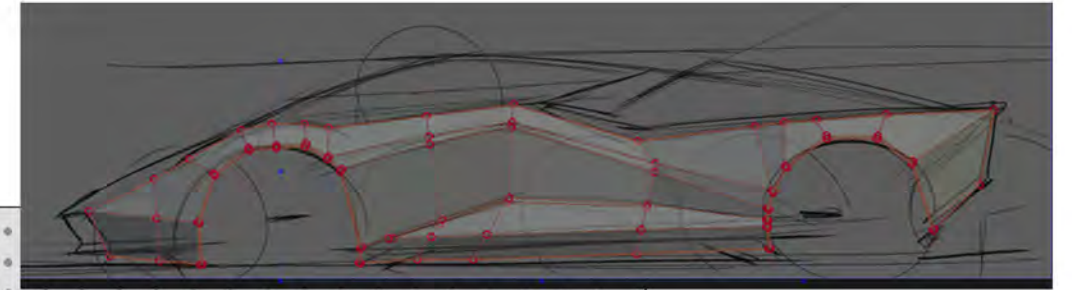
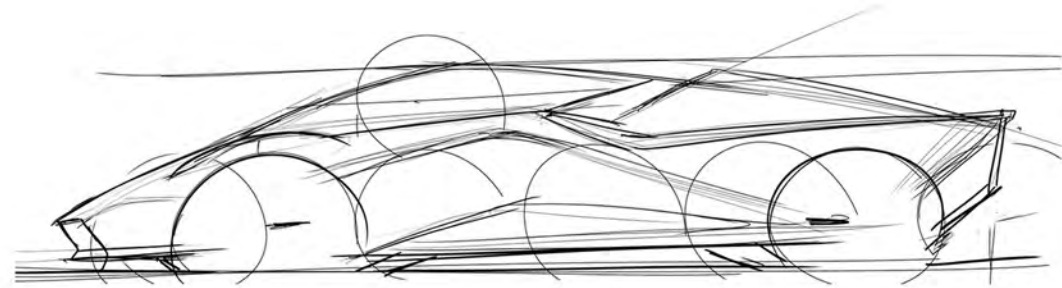

SKETCH TO MODEL PROCESS



04

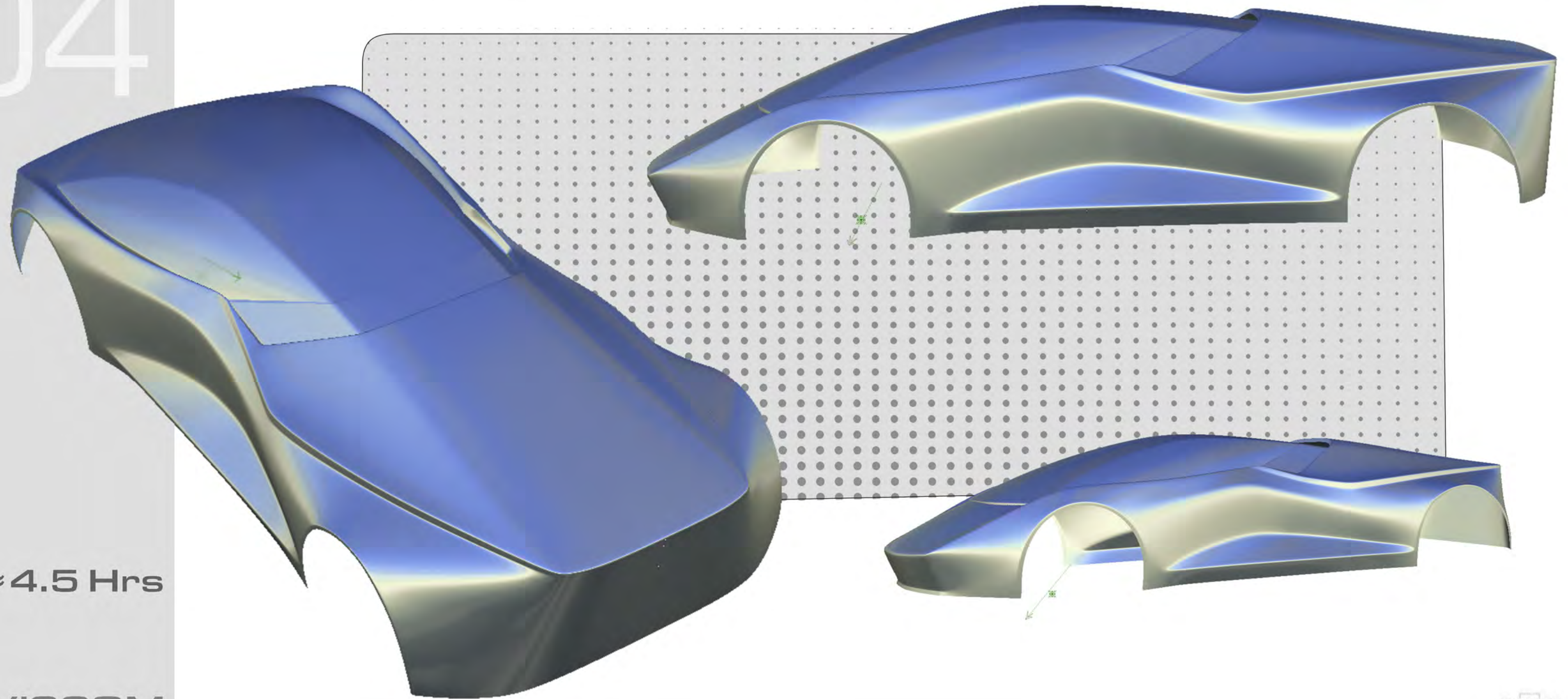

≈ 4.5 Hrs

VISCOM

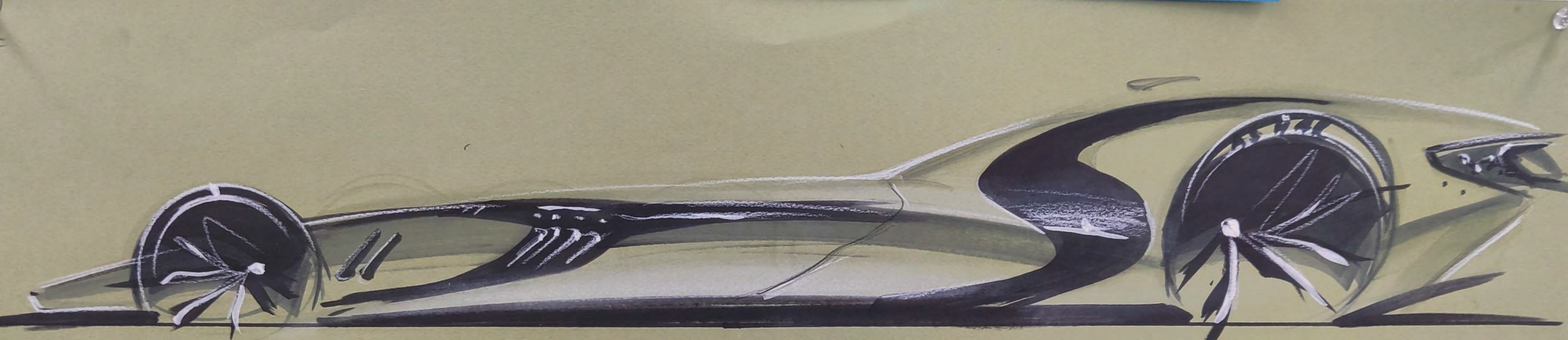
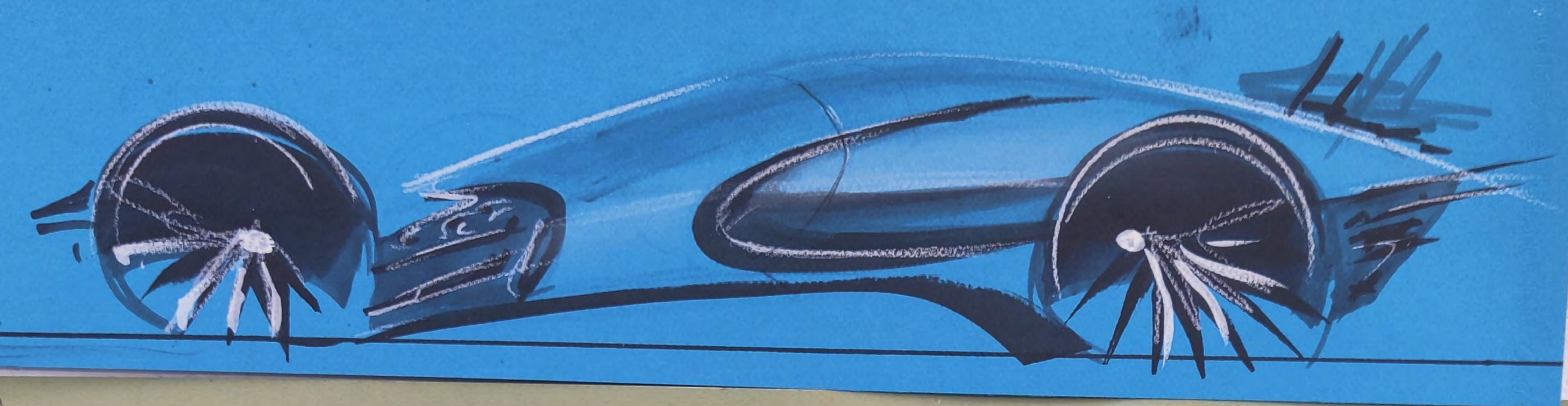

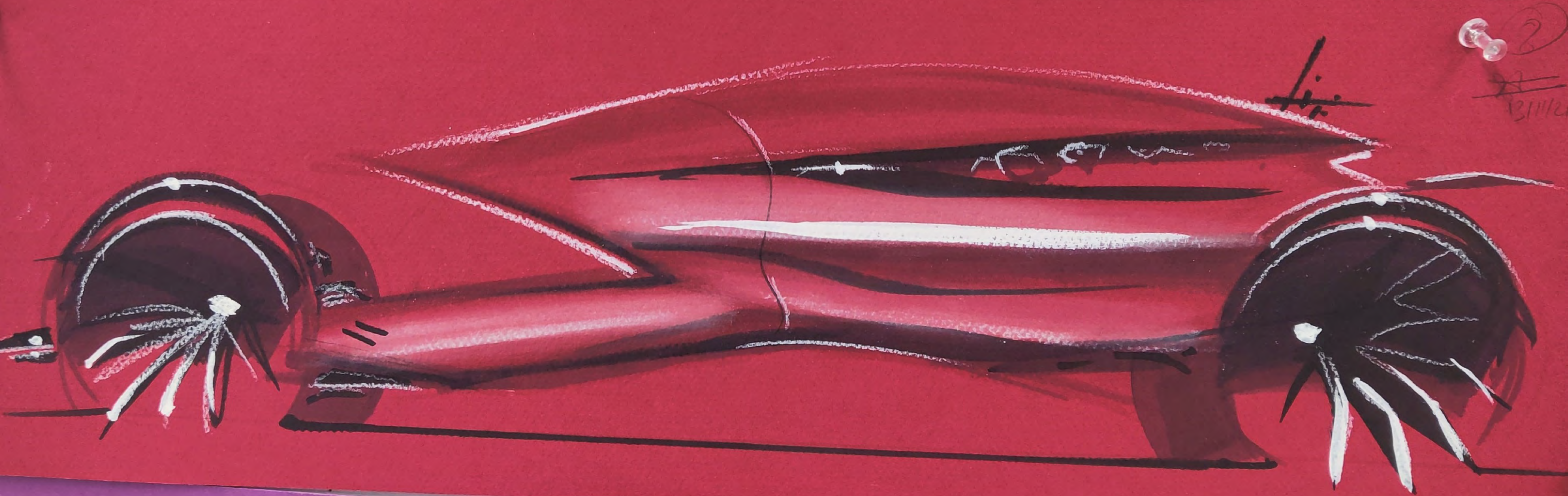
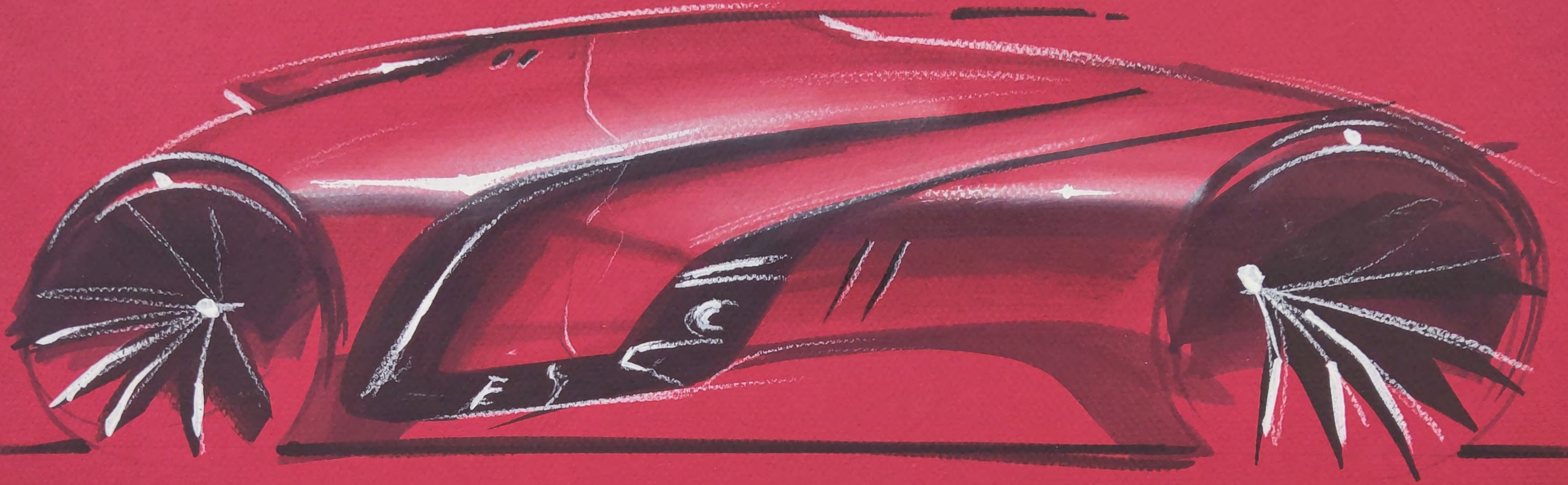

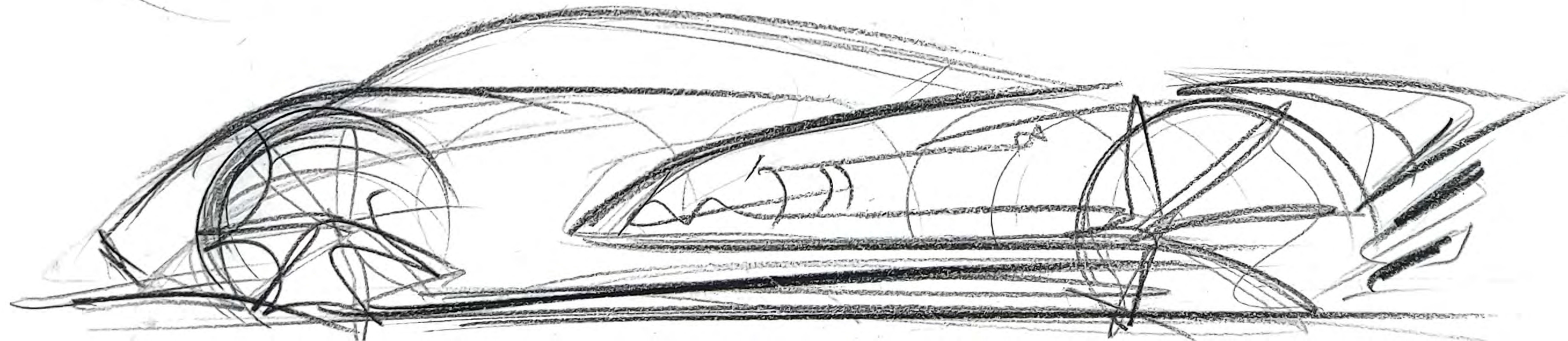
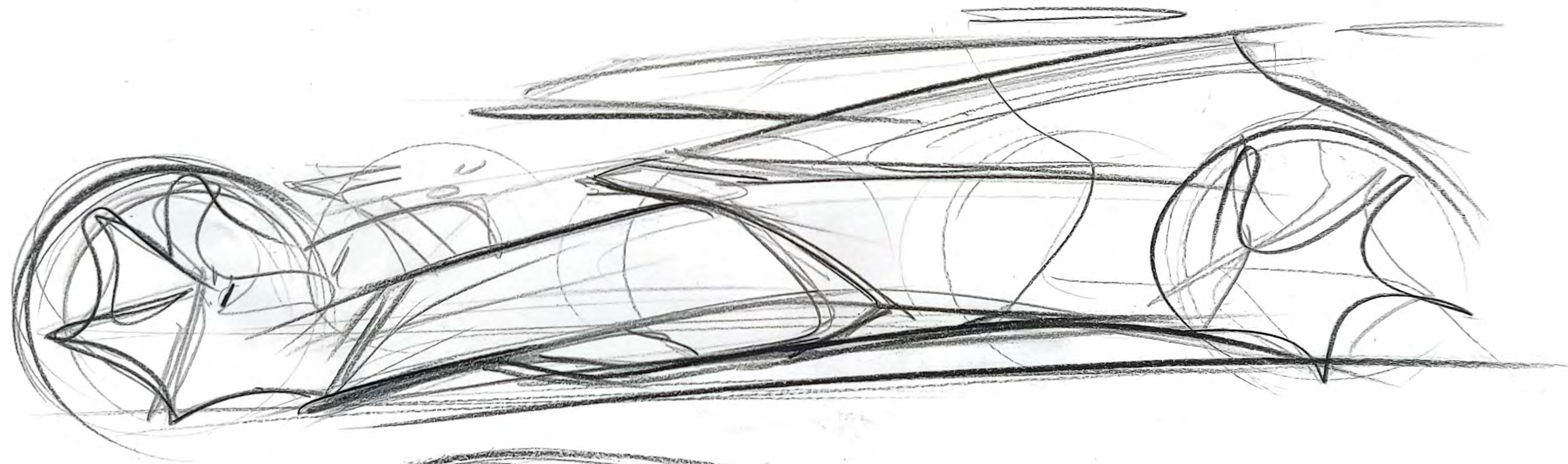
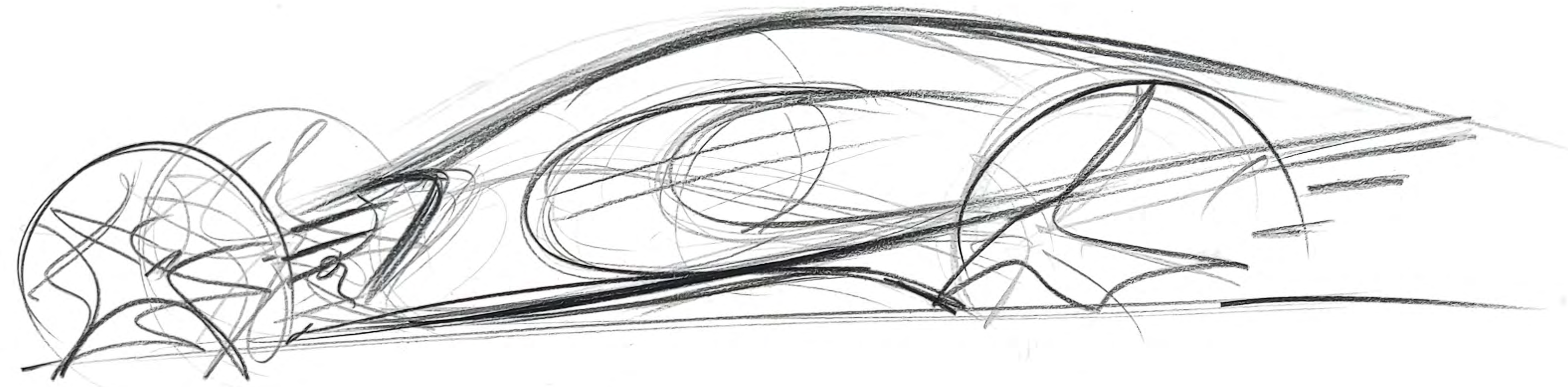

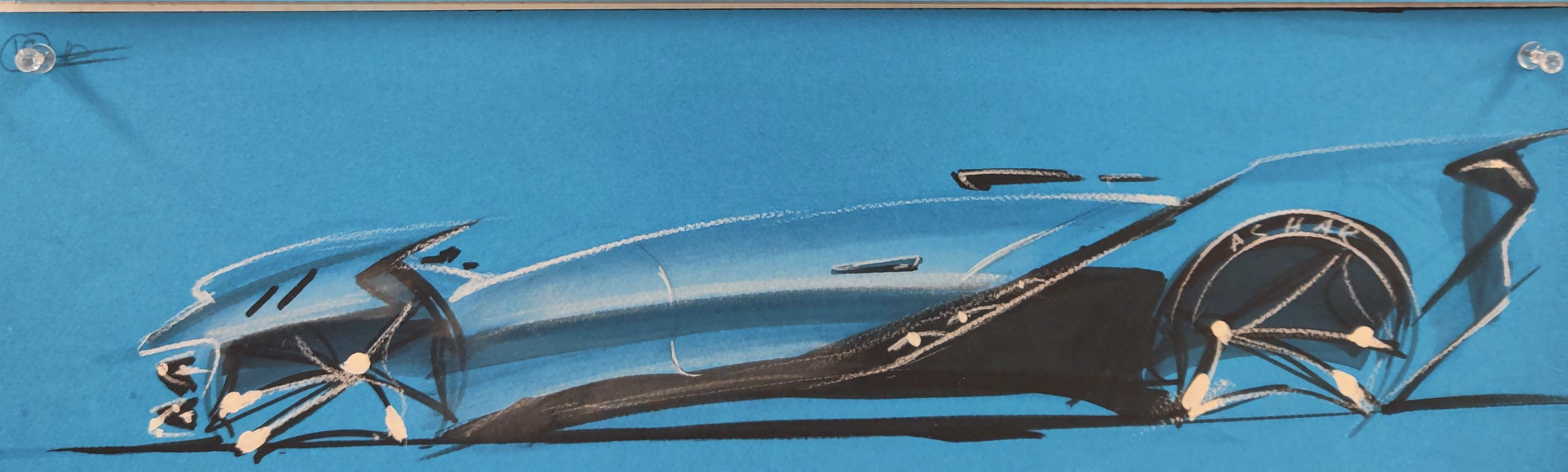
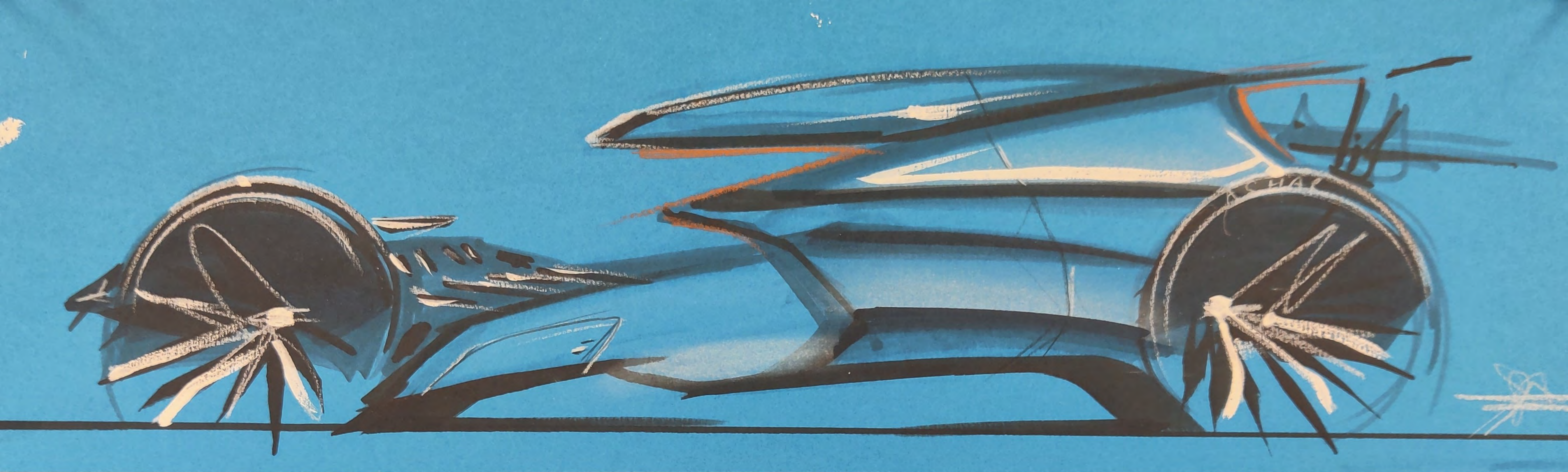

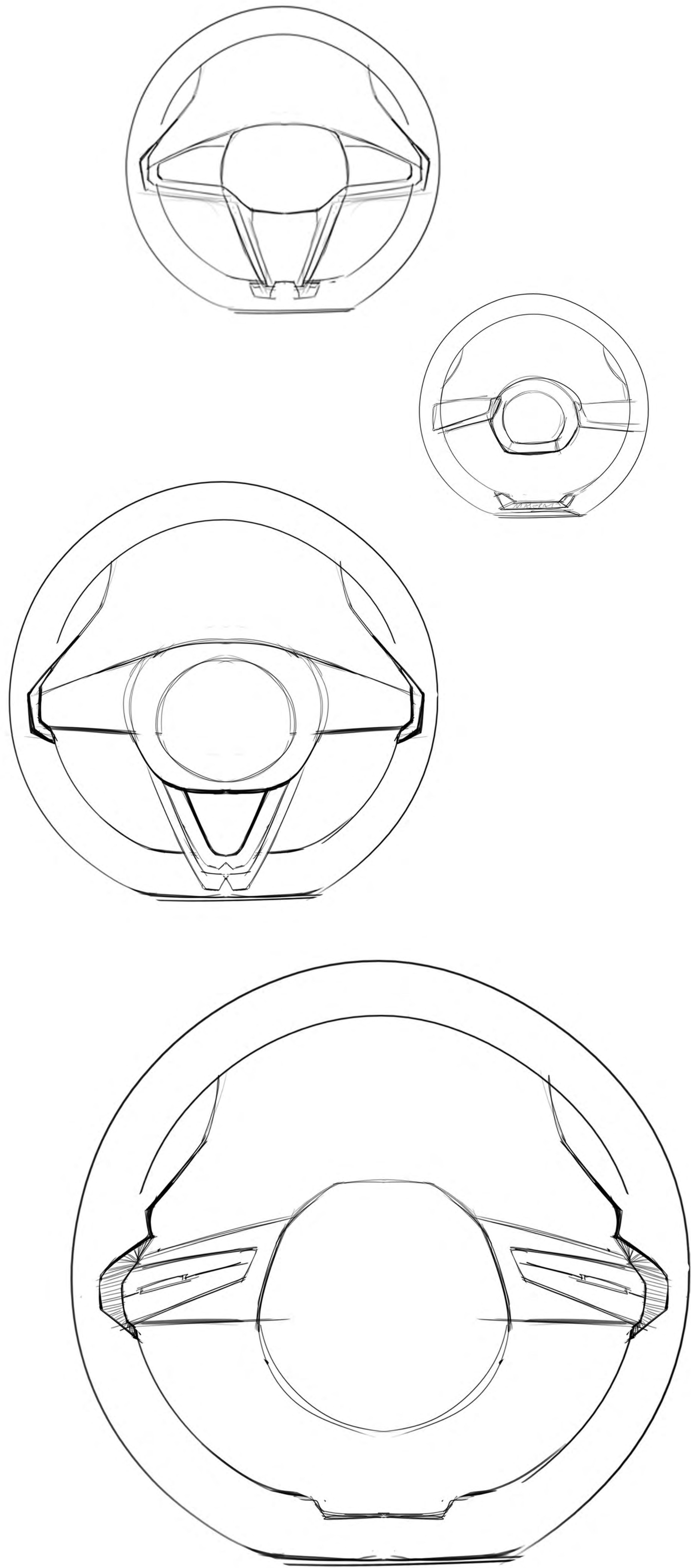
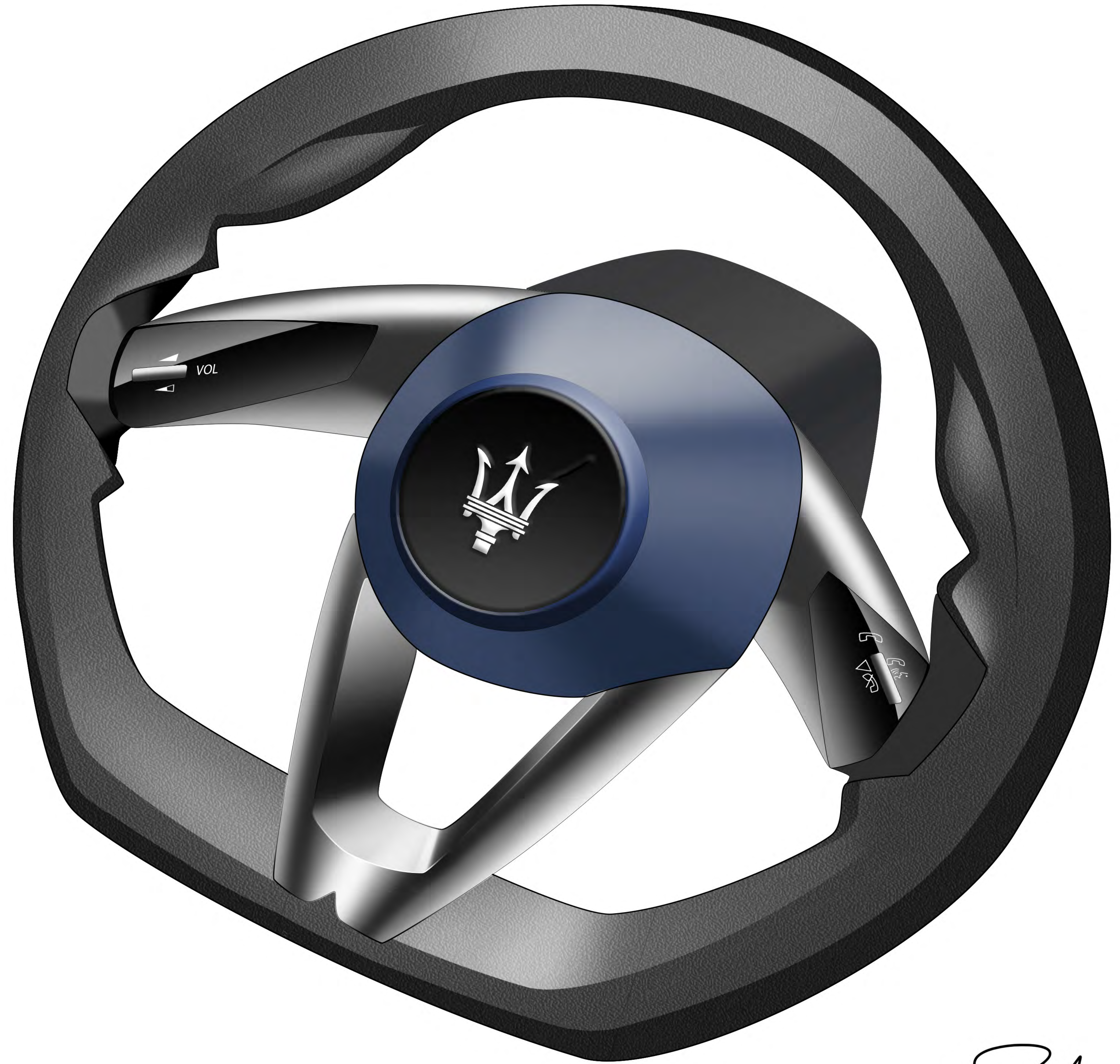

RA '24

05



Madison's **Toyota Climber Interior**

BLENDER



PROCESS

05

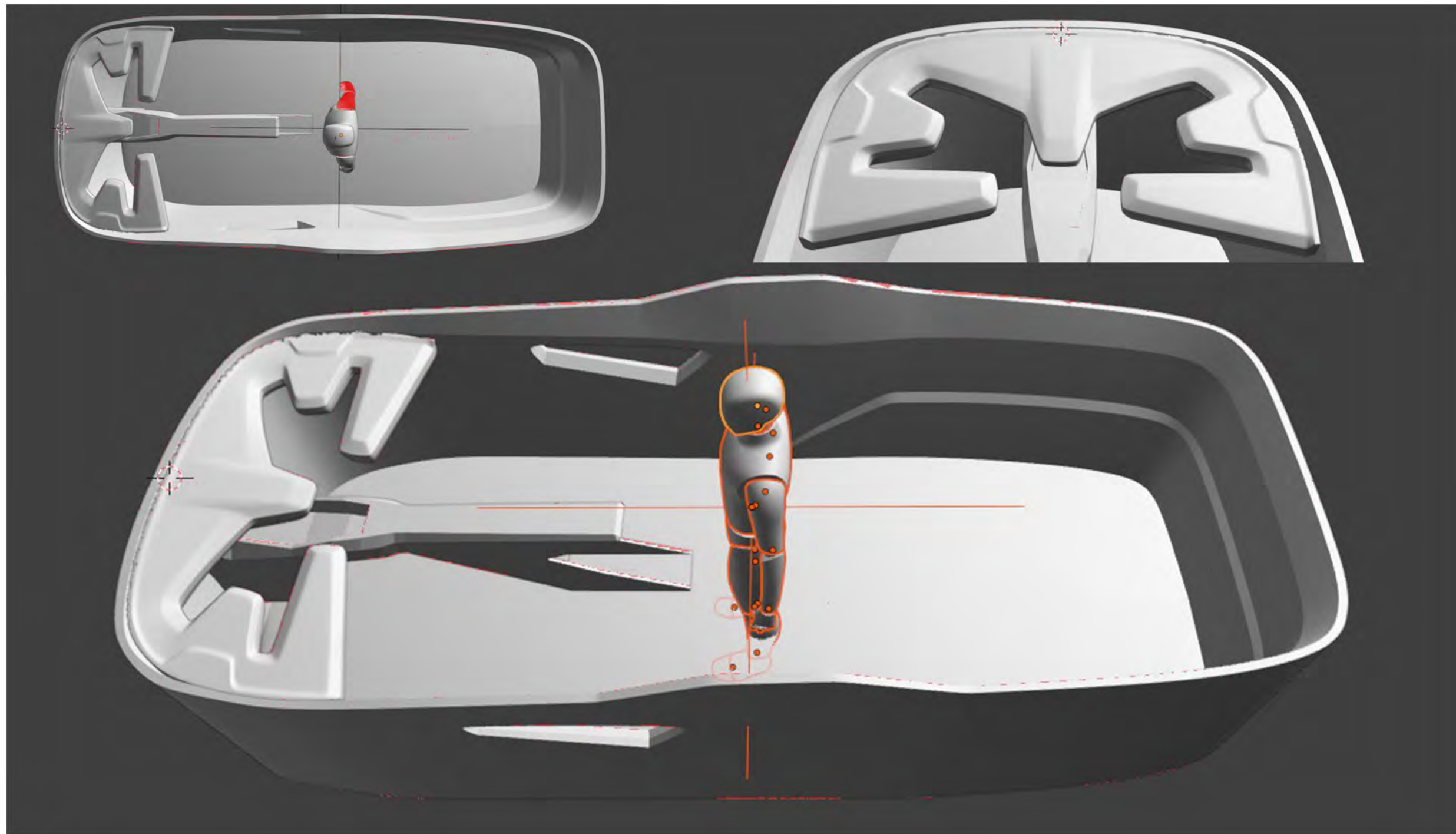

Toyota **CLIMBER**



BLENDER RENDERS



BLENDER RENDER



BLENDER RENDER



06

PORSCHE 911

UNREAL ENGINE 5

Lorem ipsum dolor sit amet, consectetur adipiscing elit, sed do eiusmod tempor incididunt ut labore et dolore magna aliqua. Quis ipsum suspendisse ultrices gravida. Risus commodo viverra maecenas accumsan lacus











THANK YOU



[linkedin.com/in/sahilashar1](https://www.linkedin.com/in/sahilashar1)



+91 8197917445 / +1 626 567 9916

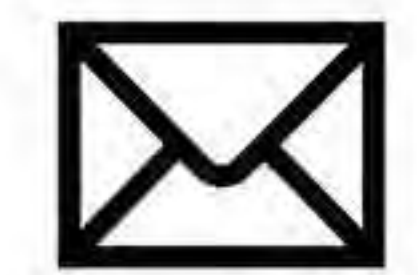

sashar@ccsdetroit.edu



sahilashar.myportfolio.com